

ASD 535

Aspirating Smoke Detector

Operating Manual



Imprint



Notice

This document, T 131 192, is valid only for the product described in section 1.

This documentation is subject to change or withdrawal without prior notice. The validity of the statements made in this documentation applies until the statements are revised by a new edition of the documentation (T number with new index). The users of this documentation are responsible for staying up-to-date about the current status of the documentation via the editor/publisher. We accept no responsibility for claims against any possible incorrect statements in this documentation which were unknown to the publisher at the time of publication. Handwritten changes and additions are not valid. This documentation is protected by copyright.

Foreign language documentation as listed in this document is always released or changed at the same time as the German edition. If there are inconsistencies between the foreign language documentation and the German documentation, the German documentation is binding.

Some words in this documentation are highlighted in **blue**. These are terms and designations which are the same in all languages and are not translated.

Users are encouraged to contact the editor/publisher if there are statements which are unintelligible, misleading, incorrect, or if there are errors.

© Securiton AG, Alpenstrasse 20, 3052 Zollikofen, Switzerland

This document, T 131 192, is available in the following languages:

German	T 131 192 de
English	T 131 192 en
French	T 131 192 fr
Italian	T 131 192 it

Current edition: Index g 16.01.2016 Po/ksa



Notice

Applicability for production version and firmware version

The following documentation is applicable only to the ASD 535 aspirating smoke detector with the following production version and firmware version:

Production version	FW version
from 160116	from 01.07.00

Other documents

Data sheet ASD 535		T 131 193	de / en / fr / it
Application guidelines for deep-freeze warehouses		T 131 390	de / en / fr / it
Application guidelines for locking systems		T 131 391	de
Material for the sampling pipe		T 131 194	multilingual (ED / FI)
Commissioning protocol		T 131 199	multilingual (EDFI)
Data sheets	XLM 35	T 140 088	de / en / fr / it
	SLM 35	T 131 197	de / en / fr / it
	RIM 35	T 131 196	de / en / fr / it
	MCM 35	T 131 195	de / en / fr / it
	SIM 35	T 140 011	de / en / fr
	SMM 535	T 140 010	de / en / fr
Installation instructions for aspirating fan unit		T 131 200	multilingual (EDFI)
Integration description ASD 535 on SecuriPro		T 131 218	de / en / fr / it

Safety information

Provided the product is deployed by trained and qualified persons in accordance with documentation T 131 192 and the hazard, safety and general information in this technical description is observed, there is no danger to persons or property under normal conditions and when used properly.

National and state-specific laws, regulations and guidelines must be observed and adhered to in all cases.

Below are the designations, descriptions and symbols of general, danger, and safety information as found in this document.



Danger

If the "Danger" notice is not properly observed, the product and any other system parts may present a hazard for persons and property, or the product and other system parts may be damaged to the extent that malfunctioning results in danger to persons and property.

- Description of which dangers can occur
- Measures and preventative actions
- How dangers can be averted
- Other safety-relevant information



Warning

The product may be damaged if the warning information is not heeded.

- Description of which damage can occur
- Measures and preventative actions
- How dangers can be averted
- Other safety-relevant information



Notice

The product may malfunction if this notice is not observed.

- Description of the notice and which malfunctions can be expected
- Measures and preventative actions
- Other safety-relevant information



Environmental protection / recycling

Neither the product nor product components present a hazard to the environment provided they are handled properly.

- Description of parts for which there are environmental issues
- Description of how devices and their parts have to be disposed of in an environmentally-friendly way
- Description of the recycling possibilities



Batteries

It is not permitted to dispose of batteries in the domestic rubbish. As the end user you are legally obliged to return used batteries. Used batteries can be returned gratis to the seller or brought to a designated recycling point (e.g. to a communal collection point or retailer). You can also send them back to the seller by post. The seller refunds the postage when old batteries are returned.

Document history

First issue **Date 18.01.2008**

Index “a” **Date 03.10.2008**

Most important changes compared with first issue:

Section	New (n) / changed (c) / deleted (d)		What / Reason
• 4.4.4.3	c	Correction smoke sensor type at b11 / b12; SSD 535-3 replace SSD 535-2	Write error

Index “b” **Date 21.04.2009**

Most important changes compared with previous issue:

Section	New (n) / changed (c) / deleted (d)		What / Reason
• 1.2	n	New application possibilities in deep-freeze warehouses.	Expanded use
• 4.2.1	c	Text before table adjusted.	Comprehensibility
• 4.3.1	c	Text correction in the second text block.	Comprehensibility
• 4.4.4.3	c	Text “superordinate” (system limits) deleted.	Comprehensibility
• 5.4.1 / Fig. 17	c	Procedure for opening the detector housing explained better.	Comprehensibility
• 6.5.1	c	Terminals 9: text changed from “free” to “unused”.	Comprehensibility
• 6.6.4.3	d	In the Notice, text correction of maximum connectable SLM 35 units on ASD 535-2 and -4.	Error
• 6.6.5 / 13	n	Specification of electrical strength of the OC outputs	Addition
• 7.2.1	n	Table C: expanded with subsequent heating time for heating control and MCM adjustments. “Various” added to table title.	New functions
• 7.2.2	n	Expanded with heating control for sampling pipe I and II.	New functions
• 7.4.3 / 8.6	c	For LS-Ü delay time, the levels “high” / “medium” / “low” re-defined.	Correction of error
• 7.5	c	New text in the “Flasher opens with basic settings” Notice; text in procedure points (4) – (6) adjusted.	Changed functions
• 7.7	d	The text “Tobacco smoke” deleted from “Point-by-point testing”.	Correction
• 8.5.4	c	State description of LED 1 changed.	Correction
• 8.5.5.1	n	“Smoke and airflow values” expanded with “MCM interval 1 s” (2 x)	New function
• 9.3	n	New point 10 describes “Cleaning the air flow sensors”. Notice referring to point 6 and point 9.	Correction
• 9.4.3	c	Warning sign before text moved and the text changed (damage to the measuring sensor).	Correction
• 11.5	n	New section: “Use in deep-freeze warehouses”.	Expanded use
• 12.1	c	Text correction: “Memory Card Modul” changed to “Memory Card Module”.	Correction
• 13	c	Temperature range expanded to -30°C Specification of the storage temperature	Expanded use Addition

Index "c" Date 01.06.2010

Most important changes compared with previous issue:

Section	New (n) / changed (c) / deleted (d)		What / Reason
• General	c	Removed from SecuriPro / SecuriLine ®	Correction
• 1.1 / 1.3 / 2.2 / Fig. 2 / 2.2.9 / 2.2.15 / 2.2.18 / 3.1 / 3.2 / Fig. 5 / 6.4 / Fig. 33 / 6.5.4 / 7.3.7 / 8.5.6 / 8.5.7 / 11.6 / Fig. 54 / 12.1 / 13	n	New SIM 35 and SMM 535 expansion modules (networking)	Expanded use
• 1.3 / 1.5	n	Accommodation of DMB 535 and OEM	Abbreviations and terms added
• 1.3 / 1.6 / 2.2.9 / 3.3 / 7.3.6 / 7.5 / 8.3 / 8.5.2	c	Software version, new = firmware version Operating software, new = firmware SW upgrade, new = FW upgrade	Correction
• 2.2.8 / 3.2 / 6.5.1	n	Description of OEM inputs	Addition
• 2.2.8 / 6.6.2	c	Correct specification of the reset impulse bandwidth: 0.5 -10 s	Correction
• 2.2.14	n	Day of the week control mentioned in the text	Addition
• 2.2.17.3 / 7.3.5 / 7.5 (9)	n	Notice, initial reset after FW upgrade	Addition
• 3.4	c	New screw length: 40 mm (mounting set)	Change
• 4.2.1 / 4.4.4.3	c	New, expanded system limits	Expansion
• 4.10 / 5.4	n	ASD sound insulation map case mentioned	Addition
• 4.11 / 13	n	FM approval	Expansion
• 5.2 / Fig. 16 / 13	c	New map case height: 148 mm	Correction
• 5.5.11 / Fig. 30	c	Tube length of flexible tube for ceiling ducts: max. 1.5 m (0.8 m removed)	Correction
• 6.5.2	c	Notice removed, notice text integrated in table	Display
• 1.1 / 1.3 / 7.2 / 7.4.3 / 6.6.3.2 / Fig. 37 / 6.6.4.3 / Fig. 40 / 8.5.3.3	n	SecuriFire integrated	Expansion
• 7.2.1 / Table B	n	Configuration option Day of the week control and sensor activation	Addition
• 7.2.1 / Table C	n	Smoke sensor operating mode configuration option	Addition
• 7.3.4 / 8.3	n	Date/time polling expanded	Addition
• 7.3.6	c	Under (3) = edition of the FW 01.04.00	Correction
• 8.5.3.3 / 10.3.1	n	New event codes and fault states: G71 for XLM (in preparation) and G73 for SIM	Expansion

Index “d” Date 31.10.2011

Most important changes compared with previous issue:

Section		New (n) / changed (c) / deleted (d)	What / Reason
• Safety information	n	Notice, battery disposal	New legislation
• Various	n	New extension module XLM 35 (eXtended Line Module) in Section/Fig.: 1.1 / 1.3 / 2.2 / Fig. 2 / 2.2.9 / 2.2.15 / 3.1 / 3.2 / Fig. 5 / 3.4 / 4.2 / 4.9.2 / 6.4 / Fig. 33 / 6.5.2 / 6.6.3.2 / Fig. 37 / 6.6.4.3 / Fig. 40 / 7.1 / 7.2 / 7.3.7 / 7.4.3 / 7.4.4 / 8.5.3.2 / 8.5.3.3 / 8.5.4 / 8.6 / 8.7 / 10.3.1 / 11.6 / 12.1 / 13	Expansion
• 1.3	d	MDI 82 line interface card for SecuriPro removed	Does not appear in the document
• 1.4	c	Picture of rating plate updated (Made in Germany)	Correction
• 1.3 / 12.1	n	IPS 35, insect protection screen, now available as replacement part	Expansion
• 2.2.9 / 6.5.1	c	Change designation SFU to MFU	New type designation
• 2.2.12.1 / 7.2.1, Table A / 7.2.2 / 8.5.3.2 / 8.5.3.3	n	New function: “Alarm 2” New event codes G10/064 for Alarm 2 smoke sensor I and G20/064 for Alarm 2 smoke sensor II	Expansion
• 2.2.12.2 / 7.2.1, Table A	n	New function: “Alarm cascade”	Expansion
• 2.2.12.3 / 7.2.1, Table C / 8.5.3.2 / 8.5.3.3	n	New function: “Isolate smoke sensor” New event groups G13 and G23 with event code 001 to 064	Expansion
• 6.2	c	Dust protection insert in the cable entries can no longer be penetrated (new = remove).	Correction
• 7.2.1, Table A	c	LS-Ü sensitivity now in 1% increments	Expansion
• 7.2.1, Table B	n	New function for sensor activation, “switch off (partial planning)”	Expansion
• 7.2.1, Table C / 7.3.5 / 8.5.3.3	c n	Text correction: Perform initial reset. New function: “Initial reset via ASD Config”, thus text removed in the notice. New event code G01/032 and G01/064	Correction / Expansion
• 7.3.6	c	Under (3) = edition of FW 01.05.00	Correction
• 7.5	c	New flasher for FW upgrade	Correction
• 8.5.3.2 / 8.5.3.3	n	New event group G04 (reset) with event code 001 to 008	Expansion
• 8.5.3.3	c n	For G02, code 001 to 004; text correction for “Smoke sensor x deactivated via ASD Config” and “Smoke sensor x activated via ASD Config”. New event codes G02/032 for “Smoke sensor II switched off (partial planning)” and G02/128 for “Smoke sensor II switched on (partial planning)”.	Correction Expansion
• 8.5.5 / Fig. 49 / 12.1	c	MCM 35 with new card holder, now with 2 GB storage card	Correction
• 11.6 / 12.1	c	Use of painted SSD 535-x CP smoke sensors	Expansion
• 11.6	c	Network cable: <u>4-wire</u> , twisted / screened (only 3 wires used)	Added text
• 12.1	c	CD “ASD Config” and “ASD PipeFlow” expanded art. no.	Correction
• 12.1	c	Cable screw union M20, new art. no.	Correction

Index “e” Date 31.07.2012**Most important changes compared with previous issue:**

Section	New (n) / changed (c) / deleted (d)		What / Reason
• 1.4	c	Updated rating plate illustration (DMC code, current consumption, extended conformity marks)	Correction
• 2.2.8 / 6.6.2	c	Voltage range of reset input and OEM inputs adapted (5 to 30 V-DC)	Correction, text correction
• 5.4.1 / 5.5.1 / 7.1 / 8 / 13	n	Notices on Australian standard	Extension
• 7.2.1	c	EN specification corrected (EN 54-20), minimum alarm threshold resolution corrected (0.0002 %/m)	Correction, text correction
• 7.3.6	c	Under (3) = edition of firmware 01.06.00	Correction

Index „f“ Date 24.06.2014**Most important changes compared with previous issue:**

Section	New (n) / changed (c) / deleted (d)		What / Reason
• 1.5	n	Reference to new Sec. 4.12, use for UL	New UL use
• 2.2.12.2	n	Notice supplemented: delay time for UL	New UL use
• 2.2.11	n	New text: “TM for comparing fire characteristic patterns”	Added text
• 4.9.1 / 6.5	n	Notice supplemented: do not use looped wire	New UL use
• 4.9.2	c	Notice: support terminals only for power supply line	New UL use
• 4.11	d	List deleted	No longer necessary
• 4.12	n	New section, use for UL	New UL use
• 6.2	n	Notice supplemented: for UL, replacement of the screw-junction pieces with AD US M-Inch adapter	New UL use
• 7.2.1	n	AI delay for UL max. 30 s	New UL use
• 7.3.4	c	Set date/time: seconds added	Correction
• 7.7.1	c	“Test with test gas” removed	Correction
• 8.5.3	c	Description of event memory: text correction in first paragraph	Correction
• 9.4.1	d	“Replace after 8 years of operation” deleted.	No longer necessary
• 12.1	n	New accessory: AD US M-Inch	New UL use
• 13	n	Note about UL use concerning supply voltage range, temperature range, relay contact, approvals	New UL use

Index "g" Date 16.01.2016

Most important changes compared with previous issue:



Section		New (n) / changed (c) / deleted (d)	What / Reason
• 4.5.2 / 4.5.4 4.5.4.1 / 4.5.5	c	Various adjustments, specifications of the alarm thresholds when planning without ASD PipeFlow calculation	Rectification
• 4.9.1 / 6.6.4.3	c	Notice about screening (observe manufacturer's specifications of the FACP and SecuriFire/Integral addressable loop)	Rectification
• 7.3.3 / 7.3.4 / 7.3.5 / 7.3.6 / 7.3.7 / 7.6.1 / 8.5.3.1	c	New table layout with  /  icon	Adaptation
• 7.3.4 / 8.3	c	Adjusting and polling date and time, now via RE / SE	Correction
• 7.3.6	c	Under (3) = FW version 01.07.00	Correction
• 7.7.2 / 8.3	n	New section for test triggers from <i>EasyConfig</i>	Extension
• 8.5.3.2 / 8.5.3.3	n	New event groups and codes for test triggers from <i>EasyConfig</i> and ASD Config	Extension
• 8.5.5	c	Industrial SD memory cards	Correction
• 12.1	c	Cable screw union in set of 10, industrial SD memory cards	Correction

Table of contents

1	General information	17
1.1	Purpose	17
1.2	Uses and applications	18
1.3	Abbreviations, symbols and terms	18
1.4	Product identification	20
1.5	Deployed smoke sensors	21
1.6	Hardware / firmware	21
2	Operation	22
2.1	General operating principle	22
2.2	Electrical operating principle	23
2.2.1	Power supply	23
2.2.2	Fan control	24
2.2.3	Microcontroller	24
2.2.4	Programming / operation	25
2.2.5	Indicators	26
2.2.6	Relays	26
2.2.7	Outputs	27
2.2.8	Inputs	27
2.2.9	Interfaces	27
2.2.10	Airflow monitoring	28
2.2.11	Smoke sensor monitoring	28
2.2.12	Alarm triggering	29
2.2.12.1	Alarm 2	29
2.2.12.2	Alarm cascade	29
2.2.12.3	Isolate smoke sensor	29
2.2.13	Autolearning	30
2.2.14	Day/night control	31
2.2.15	Fault triggering	31
2.2.16	Event memory	31
2.2.17	Reset types	32
2.2.17.1	State reset	32
2.2.17.2	Hardware reset	32
2.2.17.3	Initial reset	32
2.2.18	ASD network	32
3	Design	33
3.1	Mechanical design	33
3.2	Electrical design	35
3.3	Hardware / firmware	37
3.4	List of materials / components	38
3.5	Packaging	38

4	Planning	39
4.1	General aspects of planning	39
4.1.1	Standards, regulations, guidelines, approvals	39
4.2	Application area	39
4.2.1	System limits	40
4.3	Planning aides	40
4.3.1	Planning with “ASD PipeFlow” calculation	40
4.3.2	Planning without “ASD PipeFlow” calculation	41
4.4	Space surveillance	41
4.4.1	Space surveillance applications	41
4.4.2	Principles of space surveillance	42
4.4.3	Sampling pipe layouts for room surveillance	43
4.4.4	System limits for space surveillance without “ASD PipeFlow” calculation	44
4.4.4.1	Normative system limits for space surveillance without “ASD PipeFlow” calculation	44
4.4.4.2	Non-normative system limits for space surveillance without “ASD PipeFlow” calculation	44
4.4.4.3	System limits table for planning without “ASD PipeFlow” calculation	45
4.4.4.4	Non-normative system limits table for planning without “ASD PipeFlow” calculation	46
4.4.4.5	Sampling holes for planning without “ASD PipeFlow” calculation	47
4.4.4.6	Maintenance sampling hole	48
4.4.4.7	High-rack storage buildings	49
4.5	Equipment monitoring	50
4.5.1	Equipment monitoring applications	50
4.5.2	Principles of equipment monitoring	50
4.5.3	Types of sampling pipe layouts for equipment monitoring	51
4.5.4	System limits for equipment monitoring	51
4.5.4.1	Sampling fixtures and sampling holes in equipment monitoring	53
4.6	Two-detector dependency	54
4.7	Air recirculation	54
4.8	Settings	55
4.9	Electrical installation	56
4.9.1	Installation cable requirements	56
4.9.2	Determination of the conductor cross-section	57
4.10	Limitations	58
4.11	Environmental influences	59
4.12	Einsatz nach UL 268 und ULC-S529	59
5	Mounting	60
5.1	Mounting guidelines	60
5.2	Dimensioned drawing / drilling plan for detector housing	60
5.3	Material for the sampling pipe	61
5.4	Mounting the detector housing	62
5.4.1	Opening and closing the detector housing	63
5.4.2	Mounting positions of the detector housing	64
5.4.3	Removal of the air outlet pipe plug	65
5.4.4	Turning the labelling strips	65
5.5	Mounting sampling pipe	66
5.5.1	General information	66
5.5.2	Mounting with PVC tubes and fittings	66
5.5.3	Mounting with ABS tubes and fittings	66
5.5.4	Mounting with metal pipes and fittings	66
5.5.5	Linear expansion	67
5.5.6	Mounting the sampling pipe	68
5.5.7	Mounting for equipment monitoring	69
5.5.7.1	Screw-free fastening of the sampling pipe	69
5.5.7.2	Transition to flexible tube	70
5.5.8	Making the sampling holes	71
5.5.9	Mounting maintenance and sampling hole clips	71
5.5.10	Mounting the sampling funnel	71
5.5.11	Mounting sampling stubs for the ceiling duct	72
5.5.12	Mounting filter box, filter unit, dust trap, dust separator, water separator	73

6	Installation	74
6.1	Regulations	74
6.2	Cable entry	74
6.3	Deploying smoke sensors	75
6.4	Installing expansion modules XLM 35, SLM 35, RIM 35, MCM 35, SIM 35	76
6.5	Electrical connection	76
6.5.1	Terminal assignment of AMB 35 Main Board	77
6.5.2	eXtended Line Module XLM 35 / SecuriLine module SLM 35 terminal assignment	78
6.5.3	Relay interface module RIM 35 terminal assignment	78
6.5.4	Terminal assignment of an SIM 35 serial interface module	78
6.6	Connection variants	79
6.6.1	Power supply	79
6.6.2	Reset input	79
6.6.3	Control	80
6.6.3.1	Control via supply voltage by means of auxiliary relay	80
6.6.3.2	Control via the "Reset external" input	81
6.6.4	Wiring the FACP line	82
6.6.4.1	Circuitry on zone detection via AI / St relay	82
6.6.4.2	Circuitry on selective identification or addressable loop via AI / St relay	83
6.6.4.3	Circuitry on SecuriPro / SecuriFire / Integral addressable loop from XLM 35 / SLM 35	83
6.6.5	Open collector outputs	84
7	Commissioning	85
7.1	General information	85
7.2	Programming	86
7.2.1	Configuration options	87
7.2.2	Relay allocation	89
7.3	Starting up	89
7.3.1	Commissioning using EasyConfig	89
7.3.2	"ASD Config" configuration software	90
7.3.3	Settings on pre-defined switch settings A11 to C32, W01 to W48	91
7.3.4	Setting date and time	91
7.3.5	Initial reset	92
7.3.6	Display of firmware version	92
7.3.7	Logging off expansion modules XLM 35, SLM 35, RIM 35, MCM 35, SIM 35	93
7.4	Re-programming	93
7.4.1	Re-programming on the ASD 535	93
7.4.2	Re-programming with the "ASD Config" configuration software	93
7.4.3	Re-programming from SecuriPro / SecuriFire / Integral with SLM 35	94
7.4.4	Re-programming from SecuriFire / Integral with XLM 35	94
7.5	Loading new firmware to the ASD 535	95
7.6	Measurements	96
7.6.1	Reading out the set configuration and airflow	97
7.7	Testing and checking	98
7.7.1	Checking alarm triggering	98
7.8	Commissioning protocol	99

8	Operation	101
8.1	Indication and control elements	101
8.2	Functional sequence of operation	102
8.3	Switch settings	102
8.4	Resetting	103
8.5	Indicators	103
8.5.1	Indicators on the control unit	103
8.5.2	Indicators on the AMB 35 Main Board	104
8.5.3	Displaying and reading out the event memory	104
8.5.3.1	Procedure and interpretation of the event memory display	104
8.5.3.2	Event groups	105
8.5.3.3	Event codes within the event groups	105
8.5.4	Indication and controls on the XLM or SLM 35	109
8.5.5	Indication and control on the MCM 35	109
8.5.5.1	Data logging on the MCM 35	110
8.5.6	Indication and control on the SIM 35	110
8.5.7	Indication and control on the SMM 535	111
8.6	Control from SecuriPro with SLM 35	112
8.7	Operation from SecuriFire / Integral with XLM 35	112
9	Maintenance and service	113
9.1	General information	113
9.2	Cleaning	113
9.3	Maintenance checks, performance checks	114
9.4	Replacing units	116
9.4.1	Replacing the smoke sensors	116
9.4.2	Replacing the aspirating fan unit	116
9.4.3	Replacing the airflow sensor	117
9.4.4	Replacing the AMB 35 Main Board	117
9.4.5	Replacing printed circuit boards BCB 35 and ACB 35	117
9.5	Disposal	118
9.5.1	Deployed materials	118
10	Malfunctions	119
10.1	General information	119
10.2	Warranty claims	119
10.3	Finding and rectifying faults	120
10.3.1	Fault states	120
11	Options	123
11.1	Sampling pipe	123
11.2	Deployment in severe conditions	123
11.3	Deploying detector boxes	123
11.4	Deployment in Ex zones	124
11.5	Use in deep-freeze warehouses	124
11.6	ASD network	124
12	Article numbers and replacement parts	125
12.1	Detector housing and accessories	125
12.2	Sampling pipe and accessories	125
13	Technical data	126
14	List of figures	127

1 General information

1.1 Purpose

The ASD 535 aspirating smoke detector performs the task of taking continuous air samples via one or two sampling pipe tube networks from a monitored sector and feeding the samples to one or two smoke sensors. Thanks to this detection method and the product's excellent properties under severe ambient conditions, the ASD 535 aspirating smoke detector is used wherever problems are to be expected owing to poorly accessible monitored areas or latent disturbance variables during operation such that optimal protection can no longer be guaranteed with conventional point detectors.

The ASD 535 aspirating smoke detector is available in four versions:

- ASD 535-1 for 1 sampling tube without smoke level indicator, for 1 smoke sensor
- ASD 535-2 for 2 sampling tubes without smoke level indicator, for 2 smoke sensors
- ASD 535-3 for 1 sampling tube with smoke level indicator, for 1 smoke sensor
- ASD 535-4 for 2 sampling tubes with smoke level indicator, for 2 smoke sensors.

The SSD 535 smoke sensor is used in the ASD 535. It is available in the three following versions and sensitivity ranges:

- SSD 535-1 alarm sensitivity range 0.5%/m to 10%/m
- SSD 535-2 alarm sensitivity range 0.1%/m to 10%/m
- SSD 535-3 alarm sensitivity range 0.02%/m to 10%/m.

The ASD 535 aspirating smoke detector has four slots for expansion modules. The following modules can be added:

- XLM 35 eXtended Line Module (only if no SLM 35 fitted)
- SLM 35 SecuriLine module (only if no XLM 35 fitted)
- RIM 35 Relay Interface Module with 5 relays
- MCM 35 Memory Card Module
- SIM 35 Serial Interface Module

With the installation of an **XLM 35** eXtended Line module, the ASD 535 aspirating smoke detector can be ideally connected to the SecuriFire (SecuriLine eXtended) and Integral (X-Line) fire alarm systems via the addressable loop. Controls and changes to the ASD device configuration can be performed directly from the FACP (in preparation). Also, by means of the FACP operating software "SecuriFire Studio" or "[Integral Application Center](#)", the "ASD Config" configuration software is launched for accessing the ASDs, enabling changes to the ASD 535 (in preparation).

With the installation of an **SLM 35** SecuriLine module, the ASD 535 aspirating smoke detector can be connected via the addressable loop to the SecuriPro, SecuriFire and [Integral](#) fire alarm systems. Using the SLM 35, only simple controls and changes can be performed concerning the ASD device configuration from the FACP.

A further expansion option is the **RIM 35** Relay Interface Module. This module enables the availability of all three pre-signal levels as well as the states "smoke sensor dirty" and "LS-Ü pipe blockage" as relay contacts. The relays are also freely configurable via the "[ASD Config](#)" configuration software.

The **MCM 35** Memory Card Module serves to log operating data.

The **SIM 35** serial interface module is for networking multiple ASD 535 aspirating smoke detectors via RS485 bus. Using the "[ASD Config](#)" configuration software, all ASD 535 units present in the network can be visualised and operated from a PC. The master module in the ASD network is the SMM 535, by means of which a PC is connected.



Notice

The normative alarm transmission of the ASD 535 to the higher level point does not use the ASD network. The "Alarm" / "Fault" relays in the ASD, or the SecuriPro- / SecuriFire- / Integral addressable loop are to be used from the XLM 35 or SLM 35.

The present technical description contains all information essential for trouble-free operation. For obvious reasons only those details specific to individual countries and companies or special applications can be discussed if they are of general interest.

1.2 Uses and applications

Thanks to the detection method, air sampling by means of a sampling pipe tube network and the good properties of the product under extreme ambient conditions, the ASD 535 aspirating smoke detector is used wherever problems can be expected owing to poorly accessible areas to be monitored or due to latent disturbance variables during operation such that optimal protection cannot be guaranteed with conventional point detectors. Examples of such applications:

- **Space surveillance:**
EDP rooms, clean rooms, warehouses, high-rack storage buildings, hollow floors, protection of cultural objects, transformer stations, prison cells, etc. The ASD 535 can be used in deep-freeze warehouses as stipulated in the instructions in Application guidelines for deep-freeze warehouses, T 131 390.
- **Equipment monitoring:**
EDP systems, electrical distributors, switch cabinets, etc.

The ASD 535 is also deployed in areas where conventional point detectors are used. The local provisions and regulations must be observed from case to case.

The response behaviour of the ASD 535 has been tested in compliance with EN 54-20, Class A, B and C.

When control-unit-specific alarm transmitters, line monitoring elements etc. are used, the ASD 535 can be connected via its potential-free change-over contacts virtually without limit to all common fire alarm systems.

1.3 Abbreviations, symbols and terms

The following abbreviations, symbols and terms are used in Technical Description T 131 192. The abbreviations for tube material and accessories are listed in a separate document: T 131 194 (see also Sec. 5.3).

μ C	=	Microcontroller / microprocessor
ABS	=	Acrylonitrile-butadiene styrene (plastic)
ACB 35	=	Printed circuit board with smoke level indicator Advanced Control Board
AFS 35	=	Air Flow Sensor
AFU 35	=	Aspirating Fan Unit
AI	=	Alarm
AMB 35	=	ASD Main Board
ASD	=	Aspirating Smoke Detector
ASD Config	=	Configuration software for ASD 535
ASD PipeFlow	=	Calculation software for the sampling pipe, "ASD PipeFlow " beginning Version 2
BCB 35	=	Printed circuit board without smoke level indicator " Basic Control Board "
CE	=	Communauté Européenne (European Community)
DA	=	Detection area
Default	=	Preset values and adjustments
DET	=	Detector
DIN	=	Deutsche Industrie Norm (German industry standard)
DMB	=	Detector Mounting Box (third-party detectors / OEM)
DZ	=	Detection zone
EasyConfig	=	Commissioning procedure without configuration software " ASD Config "
EDP	=	Electronic data processing
EEC	=	European Economic Community
EEPROM	=	Memory component for system data and ASD configuration
EMC	=	Electromagnetic compatibility
EN 54	=	European standards for fire alarm systems (Germany = DIN, Switzerland = SN, Austria = Ö-Norm)
Ex-zone	=	Hazardous area
FACP	=	Fire alarm control panel
FAS	=	Fire alarm system
Fault	=	Fault
FW	=	Firmware
Flash PROM	=	Memory component for operating software



Continuation:

GND	= Supply ground (minus pin)
H-AI	= Main alarm
HF	= High frequency
HW	= Hardware
Hz	= Heating control
IEC	= International Electrotechnical Commission
Initial reset	= First start-up when commissioning
IPS 35	= Insect Protection Screen
LED	= Light-emitting diode (indicator)
LS	= Airflow
LS-Ü	= Airflow monitoring
Manufacturer	= Securiton
MCM 35	= Memory Card Module
NO / COM / NC	= Relay contacts: NO = normally open , COM = common , NC = normally closed
OC	= Open collector output
PA	= Polyamide (plastic)
PC	= Personal computer
PC	= Polycarbonate (plastic)
PE	= Polyethylene (plastic)
Pin	= Terminal pin
PMR 81	= Semi-conductor relay
Port	= Input or output component
PVC	= Polyvinyl chloride (plastic)
RAM	= Memory component
RIM 35	= Relay Interface Module
RoHS	= Restriction of Certain Hazardous Substances (environmentally friendly manufacturing processes)
SecuriFire	= Fire alarm system
SecuriLine	= Fire detector addressable loop
SecuriPro	= Fire alarm system
SIM 35	= Serial Interface Module
SLM 35	= SecuriLine module
SMM 535	= Serial Master Module
SSD 535	= Smoke sensor
St	= Fault
St-LS	= Airflow fault
SW	= Software
Te.	= Terminal
Update / Release	= Renewal / update of the operating Firmware
UMS 35	= Universal Module support
V-AI	= Pre-alarm
VDC	= Direct current voltage
VdS	= Verband der Schadenversicherer (Association of Indemnity Insurers, Germany)
VKF	= Vereinigung Kantonaler Feuerversicherungen (Cantonal Fire Insurance Union, Switzerland)
VS	= Pre-signal
Watchdog	= Monitoring of the microcontroller
XLM 35	= eXtended Line Module

1.4 Product identification

For identification, the ASD 535 and its units have inscription plates or identification plates.

The following product identifications apply:

Inscription plate on the ASD 535 and identification on the packaging

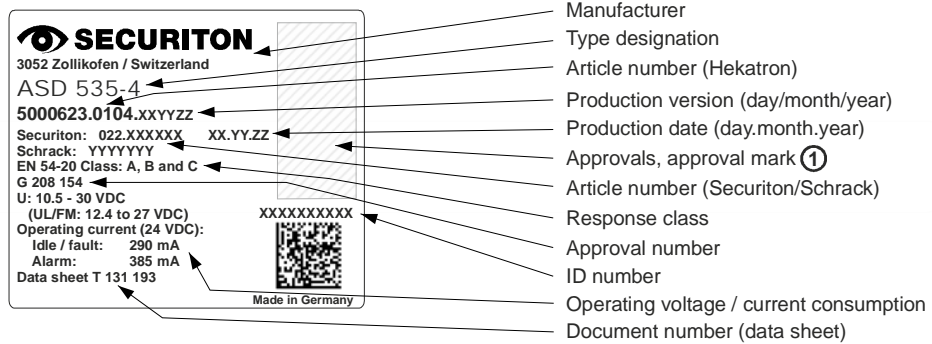

① Additional conformity marks may be affixed to a second rating plate or to an extended area of the rating plate (wider plate).

Identification on the packaging of the printed circuit boards

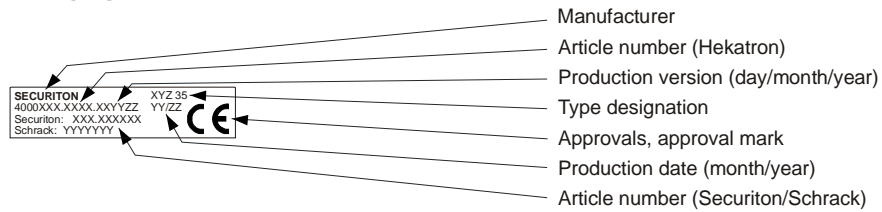

Notice

It is not permitted to remove, write over or in any way make the inscription plates, type designations and/or identifications on devices and printed circuit boards unrecognisable.

Many products, such as accessories and mounting materials, are identified only with a sticker showing the article number. The manufacturer identifies these parts by article number.

1.5 Deployed smoke sensors



Danger

Only those smoke sensors in the device approval and in the list below may be used in the ASD 535. The use of third-party detectors, for example DMB 535 (OEM), voids the ASD 535 approval issued by the manufacturer.

Smoke sensors of the following type can be used with the ASD 535 (see also Sec. 4.10 and 6.6.4):

- SSD 535-1 alarm sensitivity range 0.5%/m to 10%/m
- SSD 535-2 alarm sensitivity range 0.1%/m to 10%/m
- SSD 535-3 alarm sensitivity range 0.02%/m to 10%/m

The response sensitivity of the concerned smoke sensor can be adjusted within the above specified area. Depending on the application in accordance with EN 54-20, Class A, B or C, the value is defined via controls from the AMB 35 (fixed pre-defined switch setting as described in Sec. 4.4.4 to 4.4.4.3) or based on planning specifications with the “ASD PipeFlow” calculation software via configuration software “[ASD Config](#)” (see Sec. 7.2.1). The selection of the smoke sensor type with the respective range of sensitivity is based on the information in Sec. 4.4.4.3 or “[ASD PipeFlow](#)”.

For use compliant with **UL 268** and **ULC-S529** the alarm sensitivity ranges must be configured as specified in Sec. 4.12.

1.6 Hardware / firmware

The hardware is considered to comprise the complete ASD 535 detector housing and all units belonging to the ASD 535 aspirating smoke detector, such as sampling pipe and mounting material.

The firmware is located on the [Flash-PROM](#) in the ASD 535. An EEPROM is present for storing and saving system-specific parameters.



Danger

The ASD 535 may be operated only with the appropriate original firmware from the manufacturer. Any prohibited modification of the firmware or the use of non-original firmware may result in malfunction and/or in damage to the device. Furthermore, all guarantee and warranty rights with respect to the manufacturer of the ASD 535 will become null and void as a result.

© Copyright by Securiton

All ASD 535 firmware is subject to the manufacturer's copyright. Any prohibited modification of the firmware, any misuse, copying or prohibited sale of the firmware represents a violation of the copyright and will be legally prosecuted.



Notice

A version change or extension of the ASD 535 firmware does not imply a right to an upgrade or new release for existing ASD 535 systems.

2 Operation

2.1 General operating principle

The fan generates underpressure in the sampling pipe tube networks, and this in turn causes new air to be continuously fed to the detector housing via the sampling pipes. In this way the smoke sensors are constantly supplied with new air samples from the monitored areas. Should the smoke concentration exceed the permissible value, the ASD 535 triggers an alarm. The alarm is indicated visually on the ASD 535 and can be transmitted via a potential-free change-over contact to a superordinate fire alarm control panel.

The operational reliability of the aspirating smoke detector depends on the functional reliability of the smoke sensors and on the constant air supply to the system. Fan failure, blockage of the sampling holes or pipe breakage must be communicated to the fire alarm control panel in the form of a fault signal. This condition is satisfied by the airflow monitoring of the ASD 535.

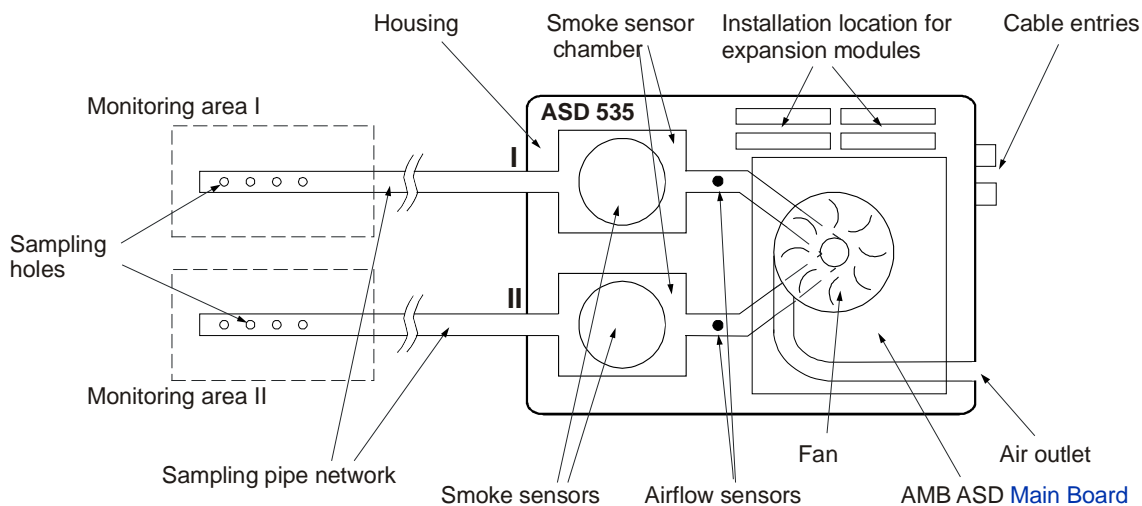

Fig. 1 General operating principle

2.2 Electrical operating principle

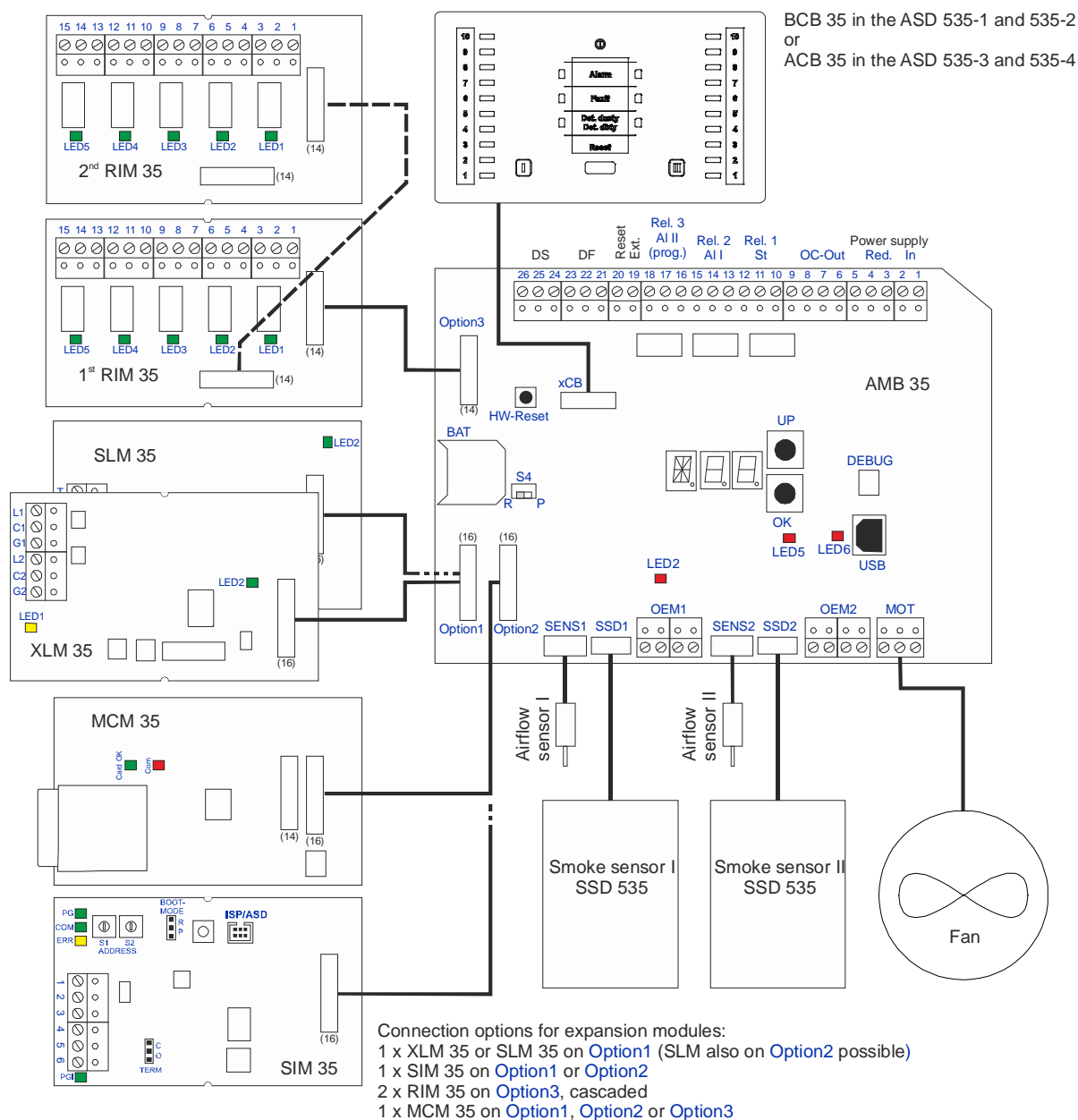

Fig. 2 Block diagram

2.2.1 Power supply

The operating voltage of the ASD 535 is +10.5 to +30 VDC (UL/FM = 12.4 to 27). On the AMB 35 Main Board, 5 VDC of the operating voltage is diverted for internal voltage use.

The operating voltage is monitored on the AMB 35 for undervoltage. If the operating voltage falls below 10.4 VDC (+0/-0.3 VDC), the ASD 535 triggers an undervoltage fault.

2.2.2 Fan control

The physical and electrical properties of a fan cause brief power surge when it is switched on and starts up, which in turn affects the conductor dimensioning and the total power consumption of the fire alarm system.

A specially designed circuit therefore ensures that the fan cannot exceed a specific maximum power consumption in its start-up phase. When the ASD 535 is switched on, the computer-controlled fan speed starts up slowly. After the fan has been powered up, the speed is kept constant.

Any blocking of the fan is detected by the evaluation of the motor current. If the specified threshold is exceeded, the fan supply is switched off and a fault is signalled.

Depending on the size of the system and/or environment, the fan can be operated at different speeds (by means of the “ASD Config” configuration software). This is useful primarily in critical sectors (long pipes) to increase the transport speed in the sampling pipe tube network (high speed) or to reduce the transport speed in cases where the noise level produced by the fan is a disturbance (low speed). The following fan speed levels can be selected:

Level	Speed (rpm)	Fan voltage (VDC)	Effect
I	2500	12.5 (±1)	Low transport speed / low noise level
II	2850	14.4 (±1)	
III	3500	18.1 (±1)	Normal transport speed / reduced noise level
IV	4150	22.0 (±1)	
V	4500	24.6 (±1)	High transport speed / normal noise level



Notice

- The fan voltage depends on the ambient temperature of the sampled air when the speed remains constant and may vary in the above specified ranges. The fan voltage specification is an approximate value and serves merely as a check value for maintenance work.
- The speed levels can be changed only with the “ASD Config” configuration software.
- For applications and commissioning **without** “ASD Config”, **Level III** is always set.
- If the fan speed is changed (by using the “ASD PipeFlow” calculation software), ensure that the maximum permissible transport time according to EN 54-20 is not exceeded.
- After the fan speed has been changed, it is **imperative** that a new initial reset is carried out (observe waiting time of at least 5 min).

2.2.3 Microcontroller

All program and switching sequences are controlled by a microcontroller. The firmware is stored in a **Flash-PROM**. System-specific configurations are stored in an EEPROM.

The program is monitored by the internal watchdog of the microcontroller. In the event of a failure of the microcontroller circuit, an emergency fault is triggered. This is indicated on the device by the “**Fault**” LED remaining continuously lit. The “**Fault**” relay switches.

2.2.4 Programming / operation

The operation of the ASD 535 aspirating smoke detector in normal mode (after commissioning) is limited to switching On/Off or resetting a triggered event (alarm/fault). Operation is generally by means of the FACP, with input of the “Zone On/Off” and “Reset” functions (on “Reset external” input of the ASD 535).

Triggered events on the ASD 535 can be reset locally with the “Reset” button on the control unit or by briefly actuating the “Reset external” input. The reset can be performed only if the triggered event is no longer pending (e.g. smoke sensor no longer has smoke). The application of a continuous signal at the “Reset external” input also deactivates (switches off) the ASD 535 (in this context, see also Sec. 2.2.8 and 6.6.2).

Notice

Local resetting does not reset a superordinate FACP. The superordinate line of the FACP may trigger a fault as a result of resetting the ASD 535.

To aid commissioning the ASD 535, there are two 7-segment displays, an alphanumeric display, and two buttons (“UP” and “OK”) inside the device on the AMB 35 Main Board. These elements render a kind of rotary switch function, i.e. indicators/ displays and positions can appear in the range of **A00** to **Z99**.

Commissioning the ASD 535 can be performed with these elements. Device settings for pre-defined system limits can also be called up (**EasyConfig**). These pre-defined settings contain normative values concerning response sensitivity, airflow monitoring (LS-Ü) and pipe configuration. They also contain settings which allow deviations from the normative limits concerning airflow monitoring. **EasyConfig** makes it possible to commission the device without the “ASD Config” configuration software. If system-specific programming has to be performed (e.g. after a calculation with “ASD PipeFlow” or when programming RIM 35), the “ASD Config” configuration software must be used.

Fig. 3 shows the workflow for defining and programming project-specific device functions.

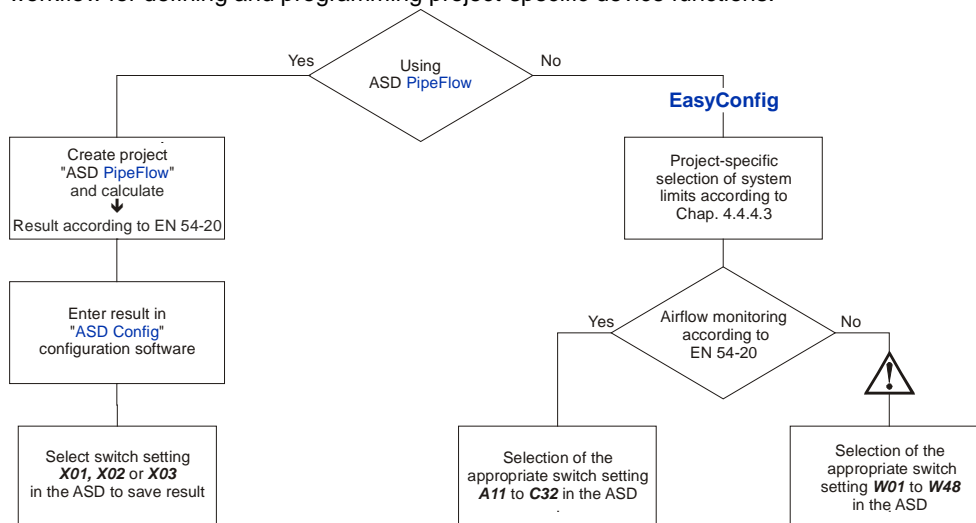

Fig. 3 Workflow of project-specific programming

Warning

Switch settings **W01** to **W48** may be used only after consulting with the manufacturer. Their configured values concerning airflow monitoring are **not** tested in accordance with EN 54-20.

The definitions of the pre-defined settings and the operator structure are found in Sec. 4.4.4.3, 4.4.4.4, 7.2.1 and 8.3.

2.2.5 Indicators

Events are displayed by LEDs on the control unit. Various indicators are present depending on the version of the device:

- ASD 535-1 operation, fault I, alarm I, pre-signal I.1–I.3, smoke sensor dirty I
- ASD 535-2 additionally: fault II, alarm II, pre-signal II.1–II.3, smoke sensor dirty II
- ASD 535-3 additionally: smoke level indicator 10, level for smoke sensor I
- ASD 535-4 additionally: smoke level indicator 10, level for smoke sensor II

Depending on the event, the LEDs may be continuously lit or flash with different frequencies (see Sec. 8.5).

2.2.6 Relays

Depending on the version of the device and installed expansion modules, the ASD 535 has several relays with potential-free change-over contacts with the following assignments:

Unit	Relay designation	Version	Function, event
AMB 35	Rel. 1: ① Fault	all	Fault (all events) ASD inactive
	Rel. 2: Alarm I	all	Smoke sensor I alarm triggering
	Rel. 3: ② Freely programmable or Alarm II	ASD 535-1 ASD 535-3 ASD 535-2 ASD 535-4	Freely programmable Smoke sensor II alarm triggering
1 st RIM 35 (from AMB 35)	Rel. 1 ②	all	Pre-signal 1 of smoke sensor I or freely programmable
	Rel. 2 ②		Pre-signal 2 of smoke sensor I or freely programmable
	Rel. 3 ②		Pre-signal 3 of smoke sensor I or freely programmable
	Rel. 4 ②		Smoke sensor I dirt or freely programmable
	Rel. 5 ②		Sampling tube I blockage or freely programmable
2 nd RIM 35 (cascaded from 1 st RIM 35)	Rel. 1 ②	ASD 535-1 ASD 535-3	Freely programmable
	Rel. 2 ②		Freely programmable
	Rel. 3 ②		Freely programmable
	Rel. 4 ②		Freely programmable
	Rel. 5 ②		Freely programmable
2 nd RIM 35 (cascaded from 1 st RIM 35)	Rel. 1 ②	ASD 535-2 ASD 535-4	Pre-signal 1 of smoke sensor II or freely programmable
	Rel. 2 ②		Pre-signal 2 of smoke sensor II or freely programmable
	Rel. 3 ②		Pre-signal 3 of smoke sensor II or freely programmable
	Rel. 4 ②		Smoke sensor II dirt or freely programmable
	Rel. 5 ②		Sampling tube II pipe blockage or freely programmable



Notice

- ① The “Fault” relay has picked up in the normal state → contact Te. 12/10 closed, 12/11 open (ASD 535 under voltage; no fault present).
- ② Depending on the device version, the relays are either configured with the above named criteria or freely programmable using the “ASD Config” configuration software (see Sec. 7.2.1 and 7.2.2).

2.2.7 Outputs

There are three open collector outputs (OC 1 to OC 3) on the ASD 535. Parallel indicators, feedback indicators or other consumers (relays) can be connected to them. Depending on the device version, the outputs are configured with the following criteria (see Sec. 6.6.5):

Unit	OC designation	Version	Function, event
AMB 35	OC 1: Fault	all	Fault (all events) / ASD inactive
	OC 2: Alarm I	all	Smoke sensor I alarm triggering
	OC 3: ① Freely programmable or Alarm II	ASD 535-1 ASD 535-3	Freely programmable
		ASD 535-2 ASD 535-4	Smoke sensor II alarm triggering



Notice

① Depending on the device version, the OC output is either configured with the above named criterion or freely programmable using the “ASD Config” configuration software (see Sec. 7.2.1 and 7.2.2). OC output 3 **always** actuates the same criterion as relay 3.

2.2.8 Inputs

The ASD 535 has an “Reset external” input which can reset the device to its normal state after an event. The input is potential-free (opto-isolator). It can be actuated both on the “plus” and on the “minus” side. The input operates in the range of 5 to 30 VDC and a pulse bandwidth of 0.5 to 10 s. On application of a continuous signal for longer than 20 s, the ASD 535 is deactivated (fault state), see also Sec. 6.6.2). Switching inactive via the “Reset external” input works only if the ASD 535 is not equipped with an XLM 35 or SLM 35.

The “OEM1” and “OEM2” inputs are for actuating alarms and faults from third-party detectors. The inputs are potential-free (opto-isolator) and can be actuated “plus” side or “minus” side in the range of 5 to 30 VDC. By default the inputs are not enabled and must be parameterised using the “ASD Config” configuration software (smoke sensor operation mode). They control the alarm and fault states on the ASD (relay + LED). The same delay times and self-holding states as for triggering from the SSD 535 apply.



Warning

- Actuations via the OEM1 and OEM2 inputs possibly may **not** comply with the requirements of **EN 54-20** and therefore may be used only after consulting with the manufacturer.
- The inputs are **not** line monitored.

2.2.9 Interfaces

Depending on the device version and installed expansion modules, the ASD 535 has the following interfaces:

Unit	Designation	Version	Function, event
AMB 35	USB	all	Configuration with “ASD Config” Update of the firmware
	+S / DS / -	all	Asynchronous data line with supply for: MFU 535 / REK 535 (①)
XLM 35	L1 / C1 / G1 // L2 / C2 / G2	all	SecurFire / Integral addressable loop
SLM 35	T / U / V // X / Y / Z	all	SecuriPro / SecuriFire / Integral addressable loop
SIM 35	GNC / D + / D -	all	RS485
others ①	Ethernet / TCP/IP	all	Ethernet (①) / TCP/IP (①)



Notice

① REK, Ethernet and TCP/IP are not yet available in the present phase.

2.2.10 Airflow monitoring

Airflow monitoring is based on the calorimetric measuring method (mass flow rate measuring method).

There are two airflow sensors installed in the detector housing so that a change in the sampling pipe (pipe breakage, pipe blockage) can be evaluated per monitoring area.

If there is an initial reset of the device and the sampling pipe is intact, the data of the airflow measurement is registered and saved as reference values (100%). The system sets the values in the middle of an electronically formed monitoring window. In the event of a shift of the values (actual values) out of the monitoring window ($\pm xx\%$) owing to pipe blockage or pipe breakage in the sampling pipe, the ASD 535 triggers an "airflow fault". The monitoring window can be set to different sizes on the ASD 535.

A variable delay time ensures that disturbance variables, e.g. air turbulence, are ignored. To handle fluctuations in the ambient temperature, the ASD 535 is equipped with a temperature compensation circuit.



Notice

A requirement for correct operation of airflow monitoring is that the airflow is logged when the ASD 535 is commissioned. With the triggering of an "Initial Reset", the data are acquired and saved in the ASD 535 as reference values (see also Sec. 2.2.17, "Reset types").

According to **EN 54-20** a change in the airflow that is greater than $\pm 20\%$ must be reported as a fault. After an initial reset, the airflow shows 100% in the ASD 535 aspirating smoke detector when the sampling pipe is correct and clean. An "airflow fault" is triggered in switch settings **A11** to **C32** if there is a change in value greater than $\pm 20\%$ – i.e. below 80% (dirt, pipe blockage) or above 120% (pipe breakage) – and if the LS-Ü delay time exceeds **300 s**.



Warning

Switch settings **W01** to **W48** are saved with airflow monitoring values which are **not tested according to EN 54-20** and therefore may be used only after consulting with the manufacturer.

2.2.11 Smoke sensor monitoring

The smoke sensors used in the ASD 535 are monitored on the AMB 35 [Main Board](#). Sensor electronics failure and dusty or dirty smoke sensors are registered as an event code and displayed as a state or fault. Likewise, the connection line between the smoke sensors and the AMB 35 is monitored and a fault is signalled if there is a failure.

To avoid false alarms, the SSD 535 smoke sensors used in the ASD 535 have a technical measure (TM) for comparing fire characteristic patterns (measure for verifying the alarm state compliant with DIN VDE 0833-2).

2.2.12 Alarm triggering

The smoke sensors cyclically transmit their states as well as the signal amplitude / smoke level to the AMB 35 [Main Board](#). The states of the smoke sensors are further processed on the AMB 35. If the set limits (alarm, pre-signals 1-3) are exceeded, the corresponding state “**Alarm**” or “**Pre-signal 1-3**” is triggered on the ASD 535.

2.2.12.1 Alarm 2

By means of the “[ASD Config](#)” configuration software you can also enable an “**Alarm 2**” for each installed ASD 535 smoke sensor. When activated, it is **always over** the “**Alarm**” of the smoke sensor (at least 20%) described in Section 2.2.12. There is no additional display on the ASD 535 if the set threshold for Alarm 2 is exceeded. Alarm 2 can be optionally programmed on a RIM relay. Alarm 2 is always a follow-up alarm of the EN 54-20 alarm and is therefore not subject to the response requirements of EN 54-20. The setting options of Alarm 2 via the “[ASD Config](#)” configuration software can be found in Section 7.2.1 (Table A).

2.2.12.2 Alarm cascade

With the “[ASD Config](#)” configuration software it is possible to activate alarm release cascade. The activated pre-signals 1 to 3 and the alarm in accordance with the set delay times (pre-signal delay time and alarm delay time) are released one after the other.



Warning

- The “cascade” function possibly may not fulfil the requirements of [EN 54-20](#) and may be used only after consulting with the manufacturer.
- When used according to [UL 268](#) and [ULC-S529](#) it is to be noted that the ASD 535 employs a maximum alarm verification time delay of **30 s** (adjustable).

2.2.12.3 Isolate smoke sensor

With this function the ASD 535 can be set to an isolated state (per smoke sensor) with the “[ASD Config](#)” configuration software. In this way test alarms can be released on the ASD 535 without actuating the superordinate systems (FACP) (relays / OC outputs / SLM / XLM do not release). When the “isolate” function is switched on, a fault is triggered on the ASD and forwarded to the superordinate point. The “fault” LED is then continuously lit on the ASD.

2.2.13 Autolearning

With the **Autolearning** function the ASD 535 is able to monitor the ambient air over a defined period of time (adjustable from one minute to fourteen days) via the sampling pipe and send the results to the system; based on that it can then determine the ideal trigger threshold of the smoke sensors. This prevents operational disturbance variables such as dust, vapour and smoke from triggering false alarms on the ASD 535. It is also possible to set a highly sensitive trigger threshold (far below the trigger threshold requirements of EN 54-20), for example for clean rooms. During **Autolearning** the biggest amplitude of the smoke sensors is determined and then multiplied by an adjustable factor of 1.1 to 10 to define the final trigger threshold. The finally determined trigger threshold, however, can never be less than the minimum possible trigger threshold (depending on the smoke sensor type, see example 2) and not greater than the trigger threshold for fulfilling the EN 54-20 requirement (see example 3). If the day/night control is activated, the values for both time periods are determined separately.

Example 1:

- Smoke sensor type = SSD 535-2 (0.1–10%/m)
- Required trigger threshold as per system limit and “ASD PipeFlow” for EN 54-20, Class C = 0.4%/m
- Selected **Autolearning** factor = 2
- Highest amplitude (smoke level) during **Autolearning** = 31%

Calculation: $0.31 \times 2 \times 0.4\%/m = 0.248\%/m$

Result: Trigger threshold of the smoke sensor = **0.248%/m**

Example 2:

- Smoke sensor type = SSD 535-3 (0.02–10%/m)
- Required trigger threshold as per system limit and “ASD PipeFlow” for EN 54-20, Class A = 0.03%/m
- Selected **Autolearning** factor = 1.1
- Highest amplitude (smoke level) during **Autolearning** = 50%

Calculation: $0.5 \times 1.1 \times 0.03\%/m = 0.0165\%/m$

Result: Trigger threshold of the smoke sensor = **0.02%/m** (minimum possible trigger threshold of the SSD 535-3)

Example 3:

- Smoke sensor type = SSD 535-2 (0.1–10%/m)
- Required trigger threshold as per system limit and “ASD PipeFlow” for EN 54-20, Class C = 0.2%/m
- Selected **Autolearning** factor = 10
- Highest amplitude (smoke level) during **Autolearning** = 16%/m

Calculation: $0.16 \times 10 \times 0.2\%/m = 0.32\%/m$

Result: Trigger threshold of the smoke sensor **remains at 0.2%/m and thereby fulfils the EN 54-20 Class C requirement.**



Notice

- If norm-compliant alarm triggering during **Autolearning** is guaranteed, the procedure is aborted. Likewise, **Autolearning** is aborted if during the procedure a change in the configuration takes place (change among the switch settings **A11 – C32**, **W01 – W48** and **X01 – X03**). If there is a power interruption on the ASD (supply line) during **Autolearning**, it will be re-started once the supply voltage is restored. If there is a deactivation (from FACP or with “Reset External”), **Autolearning** is cancelled and re-started after re-activation.
- **Autolearning** can be used only via the “ASD Config” configuration software in witch settings **X01 – X03**.
- During **Autolearning** the point (watchdog display) and the text **AL** flash on the segment display.

2.2.14 Day/night control

By means of the day/night control, the ASD 535 can be adapted to operational processes (e.g. if dust, vapour and/or smoke are produced during working hours). When day/night control is activated and at the same time the desired days of the week are activated, different trigger thresholds, pre-signals (only smoke level, not relays) and LS-Ü parameters can be assigned for each time period (see Sec. 2.2.13).



Warning

Incorrect parameter changes to the day/night mode of operation may result in non-compliance with EN 54-20.



Notice

- Day/night control can be used only via the “ASD Config” configuration software.
- The day/night control is in effect only on activated days of the week (“ASD Config”) and in the **X01 – X03** switch positions.
- On non-activated days of the week, night mode of operation is always selected.
- In addition to the watchdog indicator (flashing point in the left segment display), the point is continuously lit on the right segment display (only for the selected switch settings **X01 – X03** when the day/night control is active).

2.2.15 Fault triggering

If a fault occurs on the ASD 535, the voltage to the “Fault” relay is cut off and the “Fault” display is activated. With the aid of the error code display on the AMB 35 (switch setting **E**), it is also possible to localise the error in the event of a fault (see Sec. 8.5.3.3 and 10.3.1). The following events trigger a fault (list is incomplete):

- Airflow fault (after expiry of **LS** delay time)
- Fan fault (undershot or exceeded fan limit values, tacho signal)
- Initial reset fault
- Smoke sensor dusty / dirty
- Smoke sensor fault lacking, communication disturbance, other
- AMB 35 communication fault to control unit
- AMB 35 communication fault to XLM 35 / SLM 35 / RIM 35 / MCM 35 / SIM 35 (individual)
- Emergency fault (microcontroller failure)
- Undervoltage fault (10.4 VDC, +0 / –0.3 V)
- Supply fault (no voltage on the ASD, without “Fault” display)
- ASD inactive via “Reset external” input.



Notice

The “Fault” relay has picked up in the normal state → contact Te. 12/10 closed, 12/11 open (ASD 535 under voltage; no fault present).

2.2.16 Event memory

The ASD 535 has an event memory in which up to 430 events can be stored. The last (most recent) event is put in the first position. When the memory exceeds 430 events, the oldest is deleted. The entire event memory can be deleted only by the manufacturer. The event memory can be read out directly on the ASD 535 with the rotary switch function (switch setting **E** = last 99 events, see Sec. 8.5.3) or with the “ASD Config” configuration software (up to 430 events can be selected).

2.2.17 Reset types

All events triggered on the ASD 535 go into self-hold when the default configurations are used. For resetting, a state reset is performed.

The following reset types are possible (see Sec. 2.2.17.1 to 2.2.17.3).

2.2.17.1 State reset

A state reset is triggered by pressing the “Reset” button on the control unit or by actuating the “Reset external” input (see Sec. 6.6.2). The state reset can be triggered only after an event, but only if the criterion that resulted in the event trigger is in the normal state again (e.g. smoke level in the smoke sensor is again below the trigger threshold or a fault event is rectified). As a result of the state reset, the ASD 535 continues to run “normally” and the fan does not stop.

2.2.17.2 Hardware reset

A hardware reset is triggered if there is a brief interruption of the supply voltage or if the “HW reset” button is pressed on the AMB 35 (see **Fig. 42** and **Fig. 47**). This restarts the ASD 535. The fan stops and then slowly starts up again (start-up control). The previously programmed parameters of the ASD 535 are retained (system-specific configurations).



Notice

Attention: fire incident control, remote alerting!!

A hardware or initial reset briefly triggers the fault relay (approx. 1 s). Prior to performing maintenance on the ASD 535, it is therefore essential to switch off fire incident controls and remote alerting on superordinate systems (FACP).

2.2.17.3 Initial reset

An initial reset is triggered according to the information in Sec. 7.3.5.

As a result of an initial reset, the basic data (e.g. connected sampling pipe, airflow data) is ascertained and saved in the ASD 535. In addition, an automatic adjustment of the airflow monitoring takes place. The basic data remains stored until a further initial reset is performed. An initial reset does not discard the previously defined installation-specific parameters (system limits, response class).



Danger

- During commissioning as well as after changes to the sampling pipe (length, repairs) or after changing the fan speed, it is **imperative** that an initial reset is carried out. An initial reset must also be performed after repair work on the ASD 535 (replacement of airflow sensor, aspirating fan unit, AMB 35 [Main Board](#)).
- After an FW upgrade, an initial reset is required only if it is expressly mentioned in the concerned firmware description.
- When performing an initial reset, it is essential to be certain that the sampling pipe has been correctly implemented (sealed junctions, sampling holes correctly drilled).
- If a further initial reset has to be performed because a triggered fault in the airflow monitoring cannot be reset, it may be done only if **all** necessary measures for cleaning the sampling pipe have been implemented beforehand (including filter box / filter unit, see also Sec. 9.3). If an initial reset is carried out with blocked or dirty sampling holes, there is the danger that insufficient or no air samples will be taken and hence the ASD 535 will no longer be able to trigger an alarm.
- Prior to performing an initial reset, allow the fan to run for a minimum of 5 min (after switching on or after changing the sampling pipe).

2.2.18 ASD network

An ASD network can be implemented by using the SIM 35 and SMM 535 expansion modules. Please refer to Sec. 11.6 for more information.

3 Design

3.1 Mechanical design

The ASD 535 aspirating smoke detector consists of the detector housing and one or two sampling pipe tube networks. The sampling pipes are made of hard PVC or ABS tubes with an external diameter of 25 mm and an internal diameter of 20 mm (see also Sec. 5.3). In special applications (e.g. in an extremely corrosive environment) other tube materials may be used subject to the specifications in Sec. 5.3. The sampling pipes have several sampling holes whose size is such that each hole withdraws the same amount of air. The sampling pipes may be I-, U-, T-, H-, or E-shaped. The sampling pipes are usually symmetrically designed. Asymmetrical sampling pipe tube networks can also be implemented using the “ASD PipeFlow” calculation software.

The housing cover of the detector housing can be opened by means of the four quick-release rotary locks. In the middle area of the lower part of the detector housing are two additional mounting points for the quick-release rotary locks so that the housing cover can be re-fastened for commissioning and maintenance work when the device is open.

Integrated in the detector housing is a high-speed fan which, in conjunction with the sampling pipe, ensures uninterrupted air supply to the detector housing. Airflow monitoring detects any pipe blockage or pipe breakage per tube network in the sampling pipe.

There are two chambers for the smoke sensors in the detector housing. The air channels through the smoke sensors and fan are separated from the other parts in the detector housing; hence even when the housing cover is open the ASD 535 is able to continue functioning unimpaired during commissioning and maintenance. Smoke sensor chamber II in the ASD 535-1 and ASD 535-3 is detached so that only the air channel for smoke sensor I is active.

The AMB 35 [Main Board](#) contains the processor-controlled evaluation electronics and the connecting elements. There are four slots in the detector housing for installing optional expansion modules (XLM 35, SLM 35, RIM 35, MCM 35, SIM 35).

Depending on the device version, the housing cover of the detector housing contains either the BCB 35 printed circuit board (without smoke level indicator) or ACB 35 (with smoke level indicator). Pre-defined labelling strips are used to label the control unit. For a device mounting position that is rotated 180°, the strip can also be turned accordingly.

Smoke sensors of the following type can be used with the ASD 535 (see also Sec. 4.10 and 6.6.4):

- SSD 535-1 alarm sensitivity range 0.5%/m to 10%/m
- SSD 535-2 alarm sensitivity range 0.1%/m to 10%/m
- SSD 535-3 alarm sensitivity range 0.02%/m to 10%/m

The ASD 535 is available in four versions:

- ASD 535-1 for 1 sampling tube, for 1 smoke sensor without smoke level indicator
- ASD 535-2 for 2 sampling tubes, for 2 smoke sensors without smoke level indicator
- ASD 535-3 for 1 sampling tube, for 1 smoke sensor with smoke level indicator
- ASD 535-4 for 2 sampling tubes, for 2 smoke sensors with smoke level indicator.



Notice

Expansion modules XLM 35, SLM 35, RIM 35, MCM 35 and SIM 35 are optionally available and are built into the ASD 535 when setting up the ASD 535. A maximum of four modules can be installed.

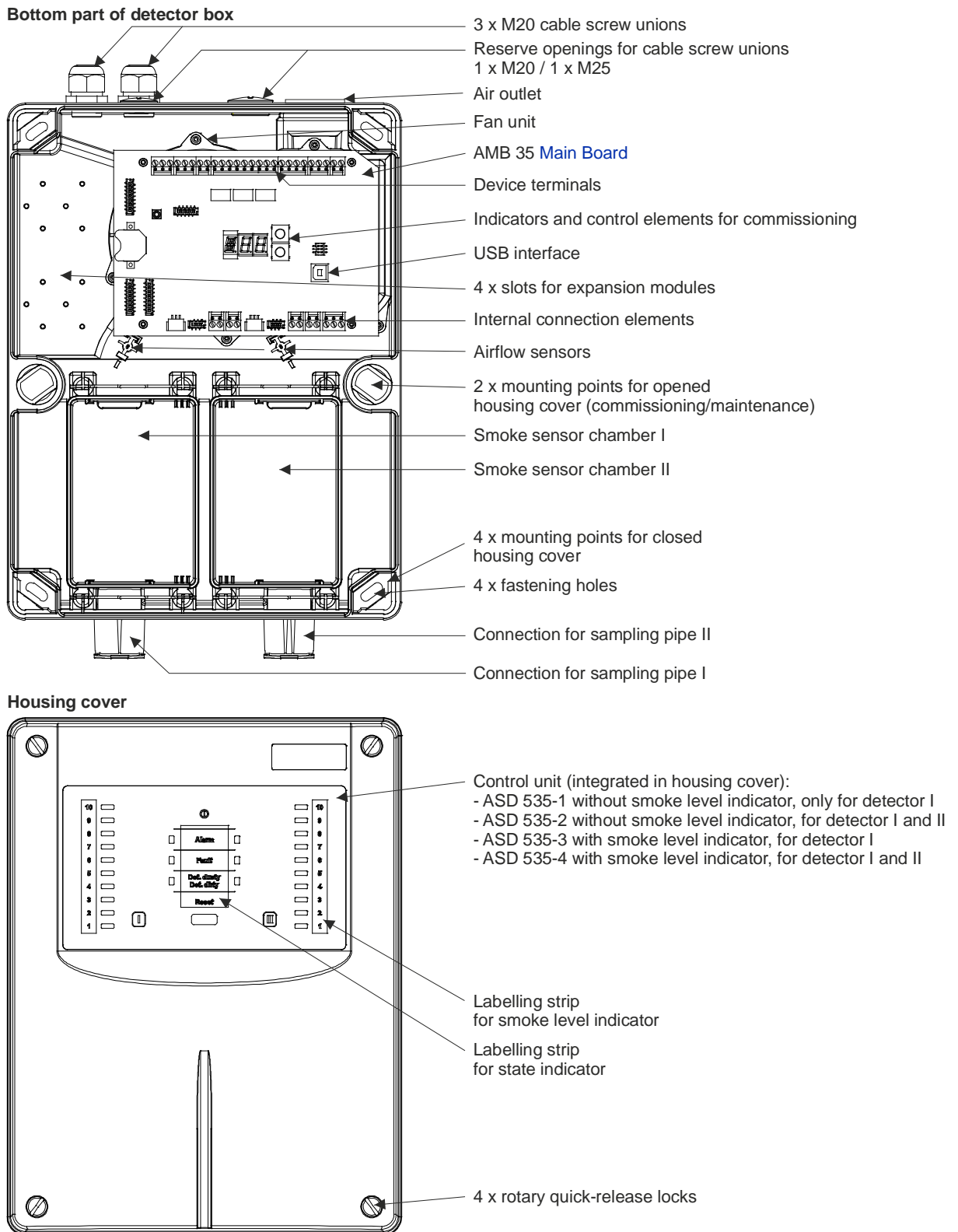

Fig. 4 Mechanical design

3.2 Electrical design

The electrical design of the ASD 535 includes the following (may vary depending on the device version):

- AMB 35 Main Board
- BCB 35 or ACB 35 printed circuit board integrated in the housing cover
- Smoke sensor I, II (SSD 535-1, -2, -3)
- Fan
- Airflow sensor I, II
- Expansion modules XLM 35, SLM 35, RIM 35, MCM 35, SIM 35.

The following circuit parts and elements are on the AMB 35 [Main Board](#):

- Power supply unit with switching controller
- Fan control with airflow evaluation and temperature measurement
- Smoke sensor evaluation
- Four opto-isolator inputs for receiving optional smoke detector states (OEM1 / OEM2)
- Opto-isolator input for reset external
- Driver modules for actuating the relays and open collector outputs
- Microcontroller with ports, RAM, [Flash](#) PROM, EEPROM, etc.
- Lithium battery
- RTC clock component
- Two buttons, one alphanumeric and two 7-segment displays for configuration settings
- Three relays with potential-free change-over contacts for fault, alarm I, alarm II
- Terminal blocks with pluggable screw terminals for the device connection
- USB port (device)
- Two LEDs for USB signal (RX [receiver] / TX [transmitter])
- LED for HW watchdog
- 10-pin flat cable connector for connecting to the control unit
- Two 16-pin flat cable connectors ([Option1](#) and [Option2](#)) for connecting the XLM 35 (only [Option1](#)), SLM 35, MCM 35, SIM 35
- One 14-pin flat cable connector ([Option3](#)) for connecting to two RIM 35 units and MCM 35 (cascaded)
- Two 6-pin flat cable connectors for connecting to the smoke sensors
- Two 3-pin connectors for connecting the airflow sensors
- HW reset button
- S4 switch for firmware upgrade

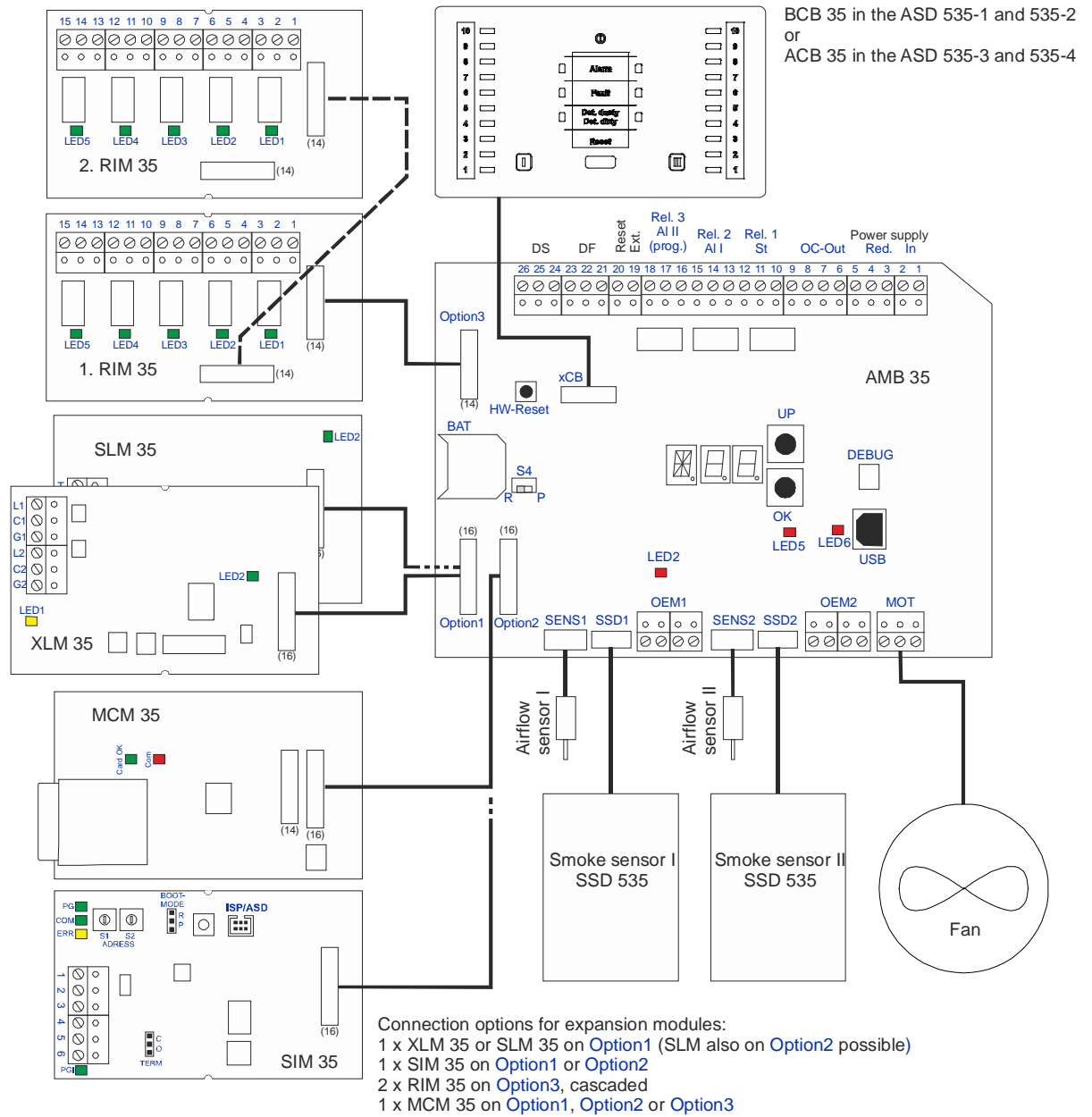

Fig. 5 Electrical design

3.3 Hardware / firmware

The hardware is considered to comprise the complete ASD 535 detector housing and all units belonging to the ASD 535 aspirating smoke detector, such as sampling pipe and mounting material.

The firmware is located on the [Flash](#) PROM in the ASD 535. An EEPROM is present for storing and saving system-specific parameters.



Danger

The ASD 535 may be operated only with the appropriate original firmware from the manufacturer. Any unauthorized intervention or manipulation of the firmware or use of non-original firmware can lead to malfunction and/or damage to the device. Furthermore, all guarantee and warranty rights with respect to the manufacturer of the ASD 535 will become null and void as a result.

© Copyright by SECURITON

All ASD 535 firmware is subject to the manufacturer's copyright. Any prohibited modification of the firmware, any misuse, copying or prohibited sale of the firmware represents a violation of the copyright and will be legally prosecuted.



Notice

A version change or extension of the ASD 535 firmware does not imply a right to an upgrade or new release for existing ASD 535 systems.

3.4 List of materials / components

Depending on the device version, the following materials are included in the ASD 535 on **delivery** (see also Sec. 5.1, 5.3, 9.5.1 and 12):

	AMB 35	Control unit (printed circuit board)	Prepared for smoke sensor I	Prepared for smoke sensor II	Commissioning protocol	Smoke sensor	XLM / SLM / RIM / MCM / SIM
ASD 535-1	yes	BCB 35	yes	--	yes	-- (accessories)	-- (accessories)
ASD 535-2	yes	BCB 35	yes	yes	yes	-- (accessories)	-- (accessories)
ASD 535-3	yes	ACB 35	yes	--	yes	-- (accessories)	-- (accessories)
ASD 535-4	yes	ACB 35	yes	yes	yes	-- (accessories)	-- (accessories)

The mounting set for all versions includes:

3 x company plates, 1 x M20 blind plug, 4 x S6 dowels, 4 x Torx wood screws (Ø 4.5 x 40 mm), 4 x M4 U-washers (Ø 4.3/12 x 1 mm)

Depending on the version of the device, the following **accessory materials** are available:

	Smoke sensors	XLM 35 or SLM 35	RIM 35	MCM 35	Interface mod.
ASD 535-1	1 x SSD 535-1, -2, -3	1 x possible	2 x possible	1 x possible	2 x possible
ASD 535-2	2 x SSD 535-1, -2, -3	1 x possible	2 x possible	1 x possible	2 x possible
ASD 535-3	1 x SSD 535-1, -2, -3	1 x possible	2 x possible	1 x possible	2 x possible
ASD 535-4	2 x SSD 535-1, -2, -3	1 x possible	2 x possible	1 x possible	2 x possible

The **material for the sampling pipe** can be purchased separately in the required quantities from the manufacturer based on the size and use of the system. This material is detailed in a separate document, **T 131 194** (see Sec. 5.3, 9.5.1 and 12).



Notice

The material for the sampling pipe is a component of the VdS device approval. Only the listed materials approved by the manufacturer may be used when installing the system (see T 131 194). Material from other sources may be used only if the manufacturer's written consent has been obtained.

A special **tool** is required for mounting and handling the ASD 535 (Torx screws). Please refer to the list in Sec. 5.1.

3.5 Packaging

The ASD 535 detector housing is delivered in a suitable telescopic cardboard box sealed with adhesive tape. This packaging is recyclable and can be reused.

Mounting set and small parts among the installation materials are packed in recyclable bags. The sampling tube is supplied in sections (approx. 4–5 m). The flexible tube is delivered in 50 m rolls.

The respective content according to Sec. 1.4 is stated on the packaging.



Warning

- Electronic components (e.g. printed circuit board) are delivered in antistatic protected packaging. These components should be removed from the packing just shortly before use or mounting.
- Only devices with unbroken or unopened seals (adhesive tape sealing) are considered to be new. Packaging should not be opened until immediately before use.
- The cardboard packaging of the detector housing meets the minimum requirement for packaging and can be stacked up to 10 times its weight.
- The packaging of the ASD 535 is suitable only to a limited extent for shipment by post or railway.
- For transport in or to tropical regions, marine transport, etc. appropriate measures must be taken (special packaging provided by the shipper).

4 Planning

4.1 General aspects of planning

4.1.1 Standards, regulations, guidelines, approvals

Section 4 “Planning“ provides guidelines for planning the ASD 535 aspirating smoke detector. These guidelines deal with the application as concerns the fulfilment of EN 54-20 and technically trouble-free operation.



Notice

The use of special fire alarm systems (e.g. ASD 535) is subject in some cases to country-specific regulations and guidelines and must therefore be approved by the responsible technical bodies and authorities (insurance companies) before implementation.



Notice

Planning guidelines, application examples and applicable regulations and directives exist for many country-, system- and application-specific uses. These documents can be requested from the manufacturer of the ASD 535 system or from the responsible technical bodies and authorities.



Danger

In principle, the country-specific regulations and guidelines apply to the intended purpose, planning and use of the ASD 535 aspirating smoke detector. The following planning specifications are subject to country-specific specifications.

The ASD 535 aspirating smoke detector conforms to the requirements of European Standard EN 54-20, Class A to C. The following applies:

- EN 54-20, Class A highly sensitive
- EN 54-20, Class B sensitive
- EN 54-20, Class C normal

4.2 Application area

To comply with a required system configuration, the ASD 535 can be connected via its potential-free change-over contacts or by using control-panel-specific line modules (e.g. XLM 35 / SLM 35) virtually without limit to all common fire alarm systems. The following factors influence which system configuration is suitable and which is used:

- Laws, regulations, guidelines
- Customer requirements
- System type and area of application
- Factors relating to the building
- New system, replacement of an existing system, expansion
- Cost/benefit ratio

4.2.1 System limits

When an ASD 535 aspirating smoke detector is used, the system limits below pertain and ensure compliance to EN 54-20 requirements. Depending on the planning process, the system limits described in Sec. 4.4 and 4.5 constitute **additional** factors.

	Class A	Class B	Class C
Max. overall length of the sampling pipe tube network per smoke sensor	300 m	300 m	300 m
Max. length from ASD to farthest sampling hole	110 m	110 m	110 m
Max. number of sampling holes per smoke sensor	18	56	120
Max. number of sampling holes per sampling branch	18	50	50

4.3 Planning aides

4.3.1 Planning with “ASD PipeFlow” calculation

The “ASD PipeFlow” calculation software is used for planning the sampling pipe tube network. Its purpose is to construct the required pipe entities with holes on a drawing in order to realise a system. The “ASD PipeFlow” calculation software provides a varied selection of tube materials, fittings and accessory parts (filter boxes, water separators, etc.). The end result of the software calculation specifies triggering whose parameters comply with the EN 54-20, Class A–C; the ASD 535 will then be programmed with these parameters. It is also necessary to select the smoke sensor type with the appropriate sensitivity range corresponding to the response sensitivity calculated by “ASD PipeFlow”.

Asymmetrical sampling pipe tube networks can also be planned and set up using the “ASD PipeFlow” calculation software. System limits for EN 54-20 compliant triggering are defined in the calculation software.

The material stored in the “ASD PipeFlow” calculation software for the sampling pipe as well as the “ASD PipeFlow” calculation software itself are components of the VdS device approval. A list of the available materials for the sampling pipe is provided in a separate document (T 131 194).

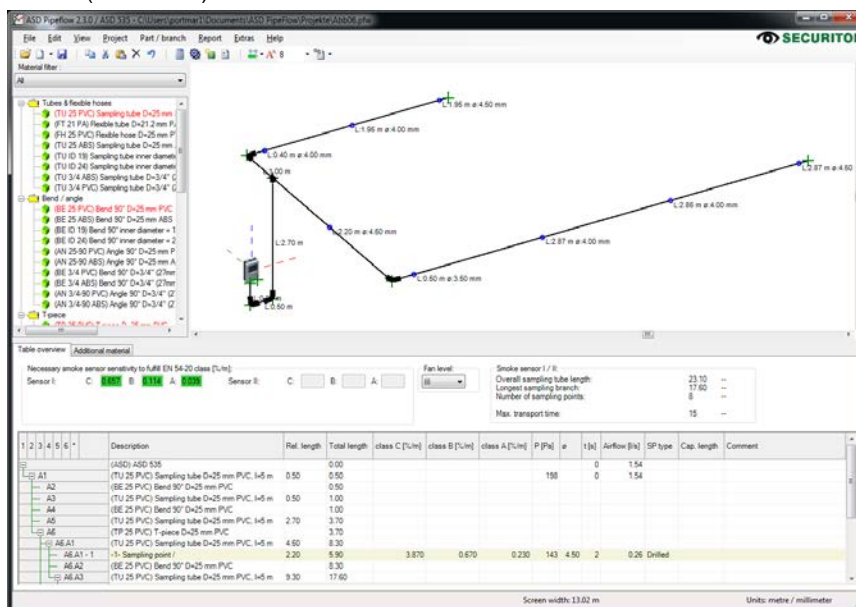

Fig. 6 “ASD PipeFlow” program interface



Notice: Modernising existing systems with the ASD 535

When modernising existing systems (aspirating smoke detectors other than ASD 535), the existing sampling pipe tube network must be re-calculated with the “ASD PipeFlow” calculation software. Before commissioning, the existing sampling pipe has to be cleaned and checked (inspected for damages).

4.3.2 Planning without “ASD PipeFlow” calculation

If planning is performed without “ASD PipeFlow”, there are a number of switch settings in the ASD 535 saved with pre-defined values which are necessary for actuation in compliance with EN 54-20, Class A–C. The selection of a smoke sensor type with the corresponding sensitivity range depends on the response class and system limits (see Sec. 4.4.4.3).



Notice about planning without “ASD PipeFlow” calculation

- Sampling pipe tube networks are principally arranged symmetrically (including sampling holes). Symmetry deviation must not exceed $\pm 10\%$.
- The maximum tube lengths and number of sampling holes stated in Sec. 4.4.4.3 may not be exceeded.
- Only the pipe materials listed in document T 131 194 with a diameter of 25 mm are permitted to be used (including flexible hose).
- A **maximum of two 90° angles** may be used per sampling pipe. Other necessary changes of direction in the sampling pipe are implemented with 90° bends.
- For each tube network, a maximum of the following accessory parts may be used:
 - ⇒ one filter box (FBL) or one dust filter unit (extra large DFU 535XL) and two detector boxes (REK), separately or combined
 - ⇒ one filter box (FBL) or one dust filter unit (extra large DFU 535XL) and one water separator (WRB), always in combination, but without detector boxes (REK).
- To use other tube and accessory parts (e.g. more than two 90° angles, flexible tubes, dust traps), it is imperative that the “ASD PipeFlow” calculation software is used.
- Equipment monitoring must be planned with the “ASD PipeFlow” calculation software.
- For applications with air recirculation, the “ASD PipeFlow” calculation software must be used.

4.4 Space surveillance

4.4.1 Space surveillance applications

The ASD 535 aspirating smoke detector can be used for the following applications (the list is not exhaustive):

- Spaces where point detectors are difficult to mount due to poor accessibility, for example:
 - cable galleries, cable tunnels, false ceilings, hollow floors
 - machine halls, production halls
 - low and high voltage rooms
 - computer rooms, clean rooms
- In extremely high spaces where monitoring is necessary on several levels, for example:
 - high-rack storage buildings
- In spaces where, for aesthetic reasons, point detectors may not be mounted, for example:
 - protection of cultural assets
 - museums
- In areas where point detectors may be damaged, for example:
 - prison cells
 - public passages
- In spaces with localised smoke development, for example:
 - warehouses with diesel forklifts
- In spaces with a high level of dust pollution and/or high atmospheric humidity.



Notice

Applications with a high level of dust and/or high atmospheric humidity require accessory parts as recommended by the manufacturer, for example: filter box / filter unit, dust trap, water separator or 3-way ball-cock for sporadic cleaning of the sampling pipe with compressed air (see also Sec. 5.5.12).

4.4.2 Principles of space surveillance



Notice

The following principles apply to space surveillance:

- The number and arrangement of the ASD 535 units are based on the size of the space.
- In general the monitoring area is the same as for point type detectors. Guidelines that apply to specific objects – e.g. high-rack storage buildings – must be observed.
- The sampling pipe tube networks are arranged so that all anticipated fires can be detected in the initial stages.
- The aspirating smoke detectors should be positioned in such a way that false alarms are avoided.
- When planning **without** “ASD PipeFlow” calculation, the sampling pipe tube networks must be arranged symmetrically (including sampling holes). Symmetry deviation must not exceed $\pm 10\%$.
- When planning **without** “ASD PipeFlow” calculation, the maximum tube lengths and number of sampling holes specified in Sec. 4.4.4.3 must **not** be exceeded.
- When there is a change of direction, a 90° bend should be used instead of a 90° angle. The detection time is influenced substantially by an excessively high number of direction changes.
- When planning **without** “ASD PipeFlow” calculation, a **maximum of two 90° angles** may be used per sampling pipe. Other necessary changes of direction in the sampling pipe are implemented with 90° bends.
- The minimum limit of the sampling tube length is **1 m** for all applications.
- Several rooms may be monitored per aspirating smoke detector only if it is permitted by the applicable guideline (e.g. DIN VDE 0833-2 in Germany, Cantonal Fire Insurance Union in Switzerland).
- The two sampling pipes (I and II) may monitor different areas only if they are located in the same climate zone. Country-specific guidelines must be observed in this case (e.g. DIN VDE 0833-2 in Germany, Cantonal Fire Insurance Union in Switzerland).
- When surveillance spaces higher than 16 m, the situation must first be clarified with the manufacturer, the insurance company and, if necessary, the fire brigade (in some cases, larger or higher monitoring areas are possible).

4.4.3 Sampling pipe layouts for room surveillance

Typical layout types for space surveillance are I-shape, U-shape, T-shape, H-shape and E-shape sampling pipe tube networks. Other sampling pipe layout designs can also be planned using the “ASD PipeFlow” calculation software.

When planning **with** “ASD PipeFlow” calculation, the sampling pipes can be different shapes for tube network I and tube network II. Likewise, irregularly spaced sampling holes are also possible (**Fig. 7**).

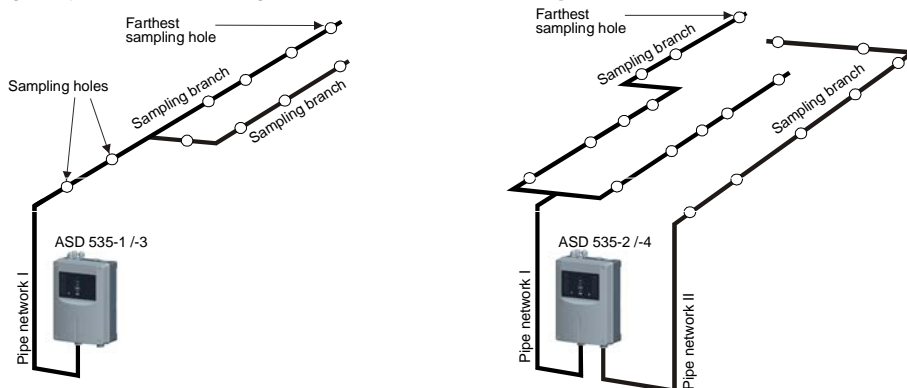

Fig. 7 Examples of planning with “ASD PipeFlow” calculation

If planning is performed **without** “ASD PipeFlow” calculation, the sampling pipe tube networks must be installed symmetrically (max. symmetry deviation of $\pm 10\%$). This concerns tube layout as well as the spacing of sampling holes. For an ASD 535-2 or ASD 535-4 (with two smoke sensors) the second sampling pipe tube network must be laid out identically to the first one (**Fig. 8**).

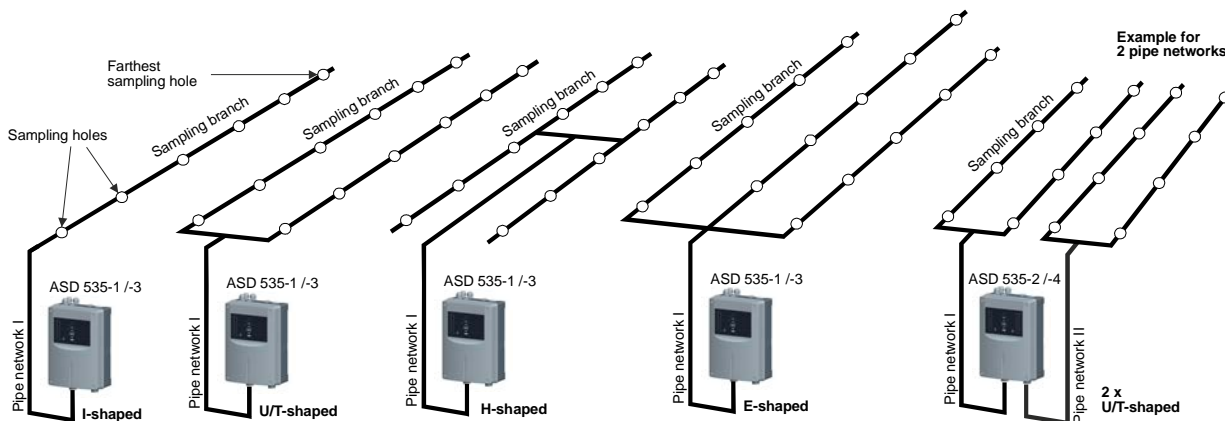

Fig. 8 Examples of planning without “ASD PipeFlow” calculation

4.4.4 System limits for space surveillance without “ASD PipeFlow” calculation

The system limits detailed in this section apply to planning without the “ASD PipeFlow” calculation software. The system limits are switch settings configured with pre-defined values. There are two areas with the following meaning:

- Normative system limits according to EN 54-20, Class A to C, switch settings **A11** to **C32**
- Non-normative system limits, switch settings **W01** to **W48**.

Fig. 9 below shows the possible sampling pipe tube networks with the definitions of the tube length specifications. The maximum tube lengths and number of sampling holes as well as the required smoke sensor types are found in the tables in Sec. 4.4.4.3 based on response class.

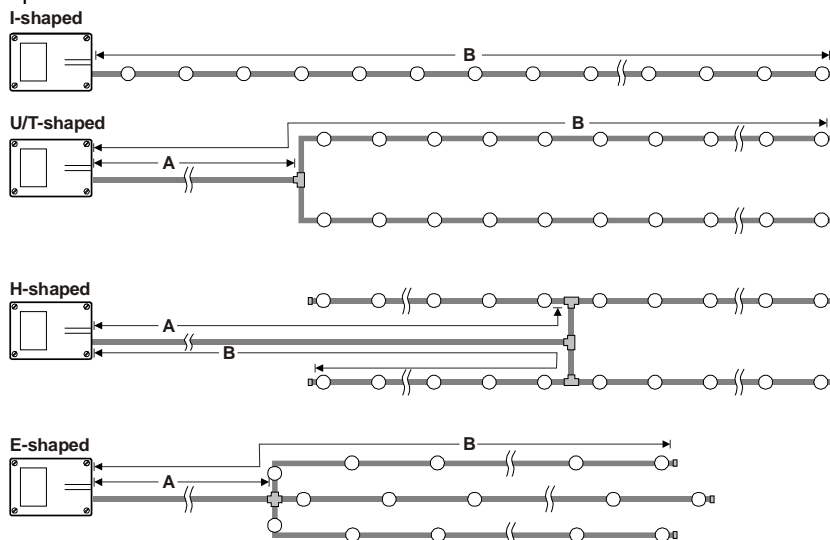

Fig. 9 Sampling pipe definitions

4.4.4.1 Normative system limits for space surveillance without “ASD PipeFlow” calculation

Switch settings **A11** to **C32** have configured values which are necessary for alarm response sensitivity and airflow monitoring in compliance with EN 54-20 Class A to C. The switch setting designation is deciphered as follows:

- First figure Response class **A, b, C** (A = highly sensitive, b = sensitive, C = standard)
- Second figure System limit **1, 2, 3** (tube network length, number of sampling holes)
- Third figure Tube networks **1, 2** (number of sampling pipe tube networks on the ASD 535).

Example: **b22** Response class **b** / system limit **2** / **2** sampling pipe tube networks.

4.4.4.2 Non-normative system limits for space surveillance without “ASD PipeFlow” calculation

Switch settings **W01** to **W48** contain system limits which fulfil only the alarm response sensitivity for EN 54-20 Class A to C **but not** the normative limits concerning airflow monitoring. Since these are identical to system limits **A11** to **C32** concerning tube topology (tube network length, number of sampling holes), switch settings **W01** to **W48** are also included in the tables below in Sec. 4.4.4.3. Additional information about switch settings **W01** to **W48** concerning number of tube networks and airflow monitoring can be found in Sec. 4.4.4.4.



Warning

Switch settings **W01** to **W48** may be used only after consulting with the manufacturer. The configured values they contain concerning airflow monitoring are not tested in accordance with EN.

4.4.4.3 System limits table for planning without “ASD PipeFlow” calculation

EN 54-20 compliance, Class A (highly sensitive)

Shape	System limit	Switch setting according to EN 54-20		Switch setting non-normative 		Smoke sensor type SSD 535	Alarm threshold (%/m)	Length from ASD to last T-piece/cross (Fig. 9 “A”)	Max. length from ASD to the farthest sampling hole (Fig. 9 “B”)	Number of sampling holes per sampling branch	Max. total length of the sampling pipe per tube network (smoke sensor)
		1 tubes	2 tubes	1 tubes	2 tubes						
I	1	A11	A12	W01 – W04	W05 – W08	-3	0.03	---	50 m	1 – 7	50 m
U / T	1	A11	A12	W01 – W04	W05 – W08	-3	0.03	1 – 20 m	40 m	1 – 4	80 m
H	1	A11	A12	W01 – W04	W05 – W08	-3	0.03	1 – 20 m	40 m	1 – 2	160 m
E	1	A11	A12	W01 – W04	W05 – W08	-3	0.03	1 – 20 m	40 m	1 – 3	120 m

EN 54-20 compliance, Class B (sensitive)

I	1	b11	b12	W09 – W12	W13 – W16	-3	0.09	---	50 m	1 – 7	50 m
	2	b21	b22	W17 – W20	W21 – W24	-3	0.06	---	70 m	5 – 9	70 m
U / T	1	b11	b12	W09 – W12	W13 – W16	-3	0.09	1 – 20 m	40 m	1 – 3	80 m
	2	b21	b22	W17 – W20	W21 – W24	-3	0.06	1 – 20 m	55 m	3 – 5	110 m
H	1	b11	b12	W09 – W12	W13 – W16	-3	0.09	1 – 20 m	35 m	1 – 2	140 m
	2	b21	b22	W17 – W20	W21 – W24	-3	0.06	1 – 20 m	45 m	2 – 3	180 m
E	1	b11	b12	W09 – W12	W13 – W16	-3	0.09	1 – 20 m	40 m	1 – 2	120 m
	2	b21	b22	W17 – W20	W21 – W24	-3	0.06	1 – 20 m	50 m	2 – 3	150 m

EN 54-20 compliance, Class C (standard)

I	1	C11	C12	W25 – W28	W29 – W32	-1	0.8	---	40 m	1 – 5	40 m
	2	C21	C22	W33 – W36	W37 – W40	-2	0.35	---	80 m	3 – 9	80 m
	3	C31	C32	W41 – W44	W45 – W48	-2	0.13	---	110 m	7 – 16	110 m
U / T	1	C11	C12	W25 – W28	W29 – W32	-1	0.8	1 – 20 m	30 m	1 – 3	60 m
	2	C21	C22	W33 – W36	W37 – W40	-2	0.35	1 – 20 m	60 m	3 – 5	120 m
	3	C31	C32	W41 – W44	W45 – W48	-2	0.13	1 – 20 m	70 m	5 – 9	140 m
H	1	C11	C12	W25 – W28	W29 – W32	-1	0.8	1 – 25 m	35 m	1 – 2	140 m
	2	C21	C22	W33 – W36	W37 – W40	-2	0.35	1 – 25 m	45 m	2 – 3	180 m
	3	C31	C32	W41 – W44	W45 – W48	-2	0.13	1 – 25 m	60 m	3 – 5	240 m
E	1	C11	C12	W25 – W28	W29 – W32	-1	0.8	1 – 20 m	30 m	1 – 2	90 m
	2	C21	C22	W33 – W36	W37 – W40	-2	0.35	1 – 20 m	50 m	2 – 3	150 m
	3	C31	C32	W41 – W44	W45 – W48	-2	0.13	1 – 20 m	60 m	3 – 6	180 m



Warning

Switch settings **W01** to **W48** may be used only after consulting with the manufacturer. The configured values they contain concerning airflow monitoring are **not** tested in accordance with EN (see Sec. 4.4.4.4)



Notice

- The diameter of the sampling holes are specified in the tables in Sec. 4.4.4.5.
- The spacing of the sampling holes are physically designed so that the resulting monitoring area meets country-specific guidelines.
- The total length of the sampling pipe must not exceed the system limits according to Sec. 4.2.1.
- The specifications apply to one and two tube networks. Tube inputs I and II are allocated, both symmetrically and identically laid out (deviation ±10%; also applies to the distance between sampling holes).
- The specifications apply with and without detector box (REK, maximum two units), large filter box (FBL), extra large dust filter unit DFU 535XL, and water separator (WRB). See Sec. 4.3.2 about equipping and combining these accessory parts.
- Filter box / filter unit and water separator must always be mounted within 2 m of the ASD 535.

4.4.4.4 Non-normative system limits table for planning without “ASD PipeFlow” calculation

The following table shows the parameters for switch settings **W01** to **W48** that do not conform to EN 54-20 concerning airflow monitoring. It also shows the number of tube networks for these switch settings. The tube topology specifications (tube network length, number of sampling holes) are shown in the tables in Sec. 4.4.4.3.



Warning

Switch settings **W01** to **W48** may be used only after consulting with the manufacturer. The configured values they contain concerning airflow monitoring are **not** tested in accordance with EN.

	Alarm triggering according to EN 54-20	System limit	Number of tube networks	Airflow monitoring		Switch setting
				Delay time	Deviation	
highly sensitive	A	1	1	10 min	± 20%	W01
	A	1	1	60 min	± 20%	W02
	A	1	1	10 min	± 50%	W03
	A	1	1	60 min	± 50%	W04
	A	1	2	10 min	± 20%	W05
	A	1	2	60 min	± 20%	W06
	A	1	2	10 min	± 50%	W07
	A	1	2	60 min	± 50%	W08
sensitive	B	1	1	10 min	± 20%	W09
	B	1	1	60 min	± 20%	W10
	B	1	1	10 min	± 50%	W11
	B	1	1	60 min	± 50%	W12
	B	1	2	10 min	± 20%	W13
	B	1	2	60 min	± 20%	W14
	B	1	2	10 min	± 50%	W15
	B	1	2	60 min	± 50%	W16
	B	2	1	10 min	± 20%	W17
	B	2	1	60 min	± 20%	W18
	B	2	1	10 min	± 50%	W19
	B	2	1	60 min	± 50%	W20
	B	2	2	10 min	± 20%	W21
	B	2	2	60 min	± 20%	W22
B	2	2	10 min	± 50%	W23	
B	2	2	60 min	± 50%	W24	
Normal	C	1	1	10 min	± 20%	W25
	C	1	1	60 min	± 20%	W26
	C	1	1	10 min	± 50%	W27
	C	1	1	60 min	± 50%	W28
	C	1	2	10 min	± 20%	W29
	C	1	2	60 min	± 20%	W30
	C	1	2	10 min	± 50%	W31
	C	1	2	60 min	± 50%	W32
	C	2	1	10 min	± 20%	W33
	C	2	1	60 min	± 20%	W34
	C	2	1	10 min	± 50%	W35
	C	2	1	60 min	± 50%	W36
	C	2	2	10 min	± 20%	W37
	C	2	2	60 min	± 20%	W38
	C	2	2	10 min	± 50%	W39
	C	2	2	60 min	± 50%	W40
	C	3	1	10 min	± 20%	W41
	C	3	1	60 min	± 20%	W42
	C	3	1	10 min	± 50%	W43
	C	3	1	60 min	± 50%	W44
C	3	2	10 min	± 20%	W45	
C	3	2	60 min	± 20%	W46	
C	3	2	10 min	± 50%	W47	
C	3	2	60 min	± 50%	W48	

4.4.4.5 Sampling holes for planning without “ASD PipeFlow” calculation

To ensure that all sampling holes take in the same amount of air, as the distance from the detector housing increases so does the diameter.

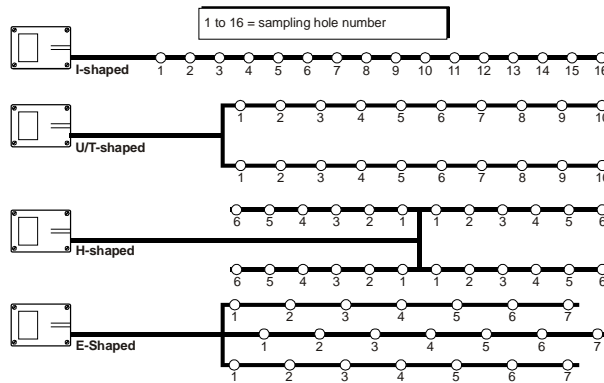

Fig. 10 Size of sampling holes

The tables below show the respective hole diameters for the numbers in Fig. 10 as a function of the number of sampling holes per sampling branch (this applies also to high-rack storage buildings).

If required, the sampling holes can be realised by means of the special “sampling hole clips”. The sampling hole clips are available in various sizes (i.e. in the hole diameters shown in the table above: 2.0 / 2.5 / 3.0 / 3.5 / 4.0 / 4.5 / 5 / 5.5 / 6 / 6.5 / 7 mm). See also Sec. 5.5.9.

I-shaped sampling pipes																
Number of sampling holes per sampling branch	Hole diameter in mm for the sampling hole number from the detector housing:															
	1	2	3	4	5	6	7	8	9	10	11	12	13	14	15	16
1	5.0															
2	4.0	5.0														
3	4.0	4.0	5.0													
4	3.5	3.5	4.0	5.0												
5	3.5	3.5	3.5	4.0	5.0											
6	2.5	2.5	2.5	2.5	3.0	5.0										
7	2.5	2.5	2.5	2.5	2.5	2.5	5.0									
8	2.5	2.5	2.5	2.5	2.5	2.5	2.5	5.0								
9	2.5	2.5	2.5	2.5	2.5	2.5	2.5	2.5	5.0							
10	2.0	2.0	2.0	2.5	2.5	2.5	2.5	2.5	3.0	7.0						
11	2.0	2.0	2.0	2.0	2.5	2.5	2.5	2.5	2.5	4.0	7.0					
12	2.0	2.0	2.0	2.0	2.0	2.0	2.5	2.5	2.5	2.5	4.0	7.0				
13	2.0	2.0	2.0	2.0	2.0	2.0	2.0	2.5	2.5	2.5	2.5	4.0	7.0			
14	2.0	2.0	2.0	2.0	2.0	2.0	2.0	2.0	2.0	2.5	2.5	2.5	4.0	7.0		
15	2.0	2.0	2.0	2.0	2.0	2.0	2.0	2.0	2.0	2.0	2.0	2.5	2.5	4.0	7.0	
16	2.0	2.0	2.0	2.0	2.0	2.0	2.0	2.0	2.0	2.0	2.0	2.0	2.0	2.5	4.0	7.0

U/T-shaped sampling pipes									
Number of sampling holes per sampling branch	Hole diameter in mm for the sampling hole number from the detector housing:								
	1	2	3	4	5	6	7	8	9
1	5.0								
2	4.0	5.0							
3	4.0	4.0	5.0						
4	4.0	4.0	4.0	5.0					
5	4.0	4.0	4.5	5.0	6.5				
6	3.0	3.0	3.5	3.5	4.0	6.5			
7	2.5	3.0	3.0	3.5	3.5	4.0	6.5		
8	2.5	2.5	3.0	3.0	3.5	3.5	3.5	7.0	
9	2.5	2.5	3.0	3.0	3.5	3.5	3.5	3.5	7.0

H/E-shaped sampling pipes						
Number of sampling holes per sampling branch	Hole diameter in mm for the sampling hole number from the detector housing:					
	1	2	3	4	5	6 (E-shaped only)
1	5.0					
2	4.0	5.0				
3	4.0	4.0	5.5			
4	3.0	3.0	3.5	5.5		
5	2.5	3.0	3.0	3.0	6.0	
6 (E-shaped only)	2.5	2.5	3.0	3.0	3.5	6.0

4.4.4.6 Maintenance sampling hole

In applications with sampling holes that are difficult to access, a maintenance sampling hole can be made immediately after the detector housing in the sampling pipe if necessary. The maintenance sampling hole must be drilled with a hole diameter of 3.5 mm. The distance from the detector housing must be at least 0.5 m.

If required, the maintenance sampling hole can be realised by means of the special “maintenance clip” (clip without drilling). See also Sec. 5.5.9.

Please note the following information:

Notice



When making a maintenance sampling hole, observe the following principles:

- A maintenance sampling hole should be made only if required, for example where normal sampling holes are difficult to access.
- A maintenance sampling hole is not included in the calculations as per Sec. 4.4.4.3 and 4.4.4.4.
- The maintenance sampling hole is only for maintenance purposes to test the ASD 535 for alarming.
- In normal operation (no maintenance), the maintenance sampling hole must be closed with adhesive tape or a “maintenance clip” if available.
- All maintenance work concerning air flow monitoring (initial reset) must be performed with closed maintenance sampling holes.

4.4.4.7 High-rack storage buildings

According to applicable guidelines (e.g. DIN VDE 0833-2), high-rack storage buildings have to be monitored by fire detectors at several heights. This also applies when using the ASD 535 instead of point detectors. The sampling holes have to be at different levels (Fig. 11). When implementing U-shape sampling pipes, arranging the sampling branches at the same height (next to each other) must be avoided. Depending on the applicable guidelines, an additional ceiling monitoring may also be required. When this is the case, the maximum space heights for smoke detectors specified in DIN VDE 0833-2 do not apply. The figure below shows examples of how the arrangement of the ASD 535 sampling pipes can be laid out in high-rack storage buildings. REK detector boxes may have to be used for limiting the detection area (12 m) (see Sec. 11.3).

Important: Applicable country-specific guidelines must be observed (e.g. DIN VDE 0833-2 in Germany, Cantonal Fire Insurance Union in Switzerland).

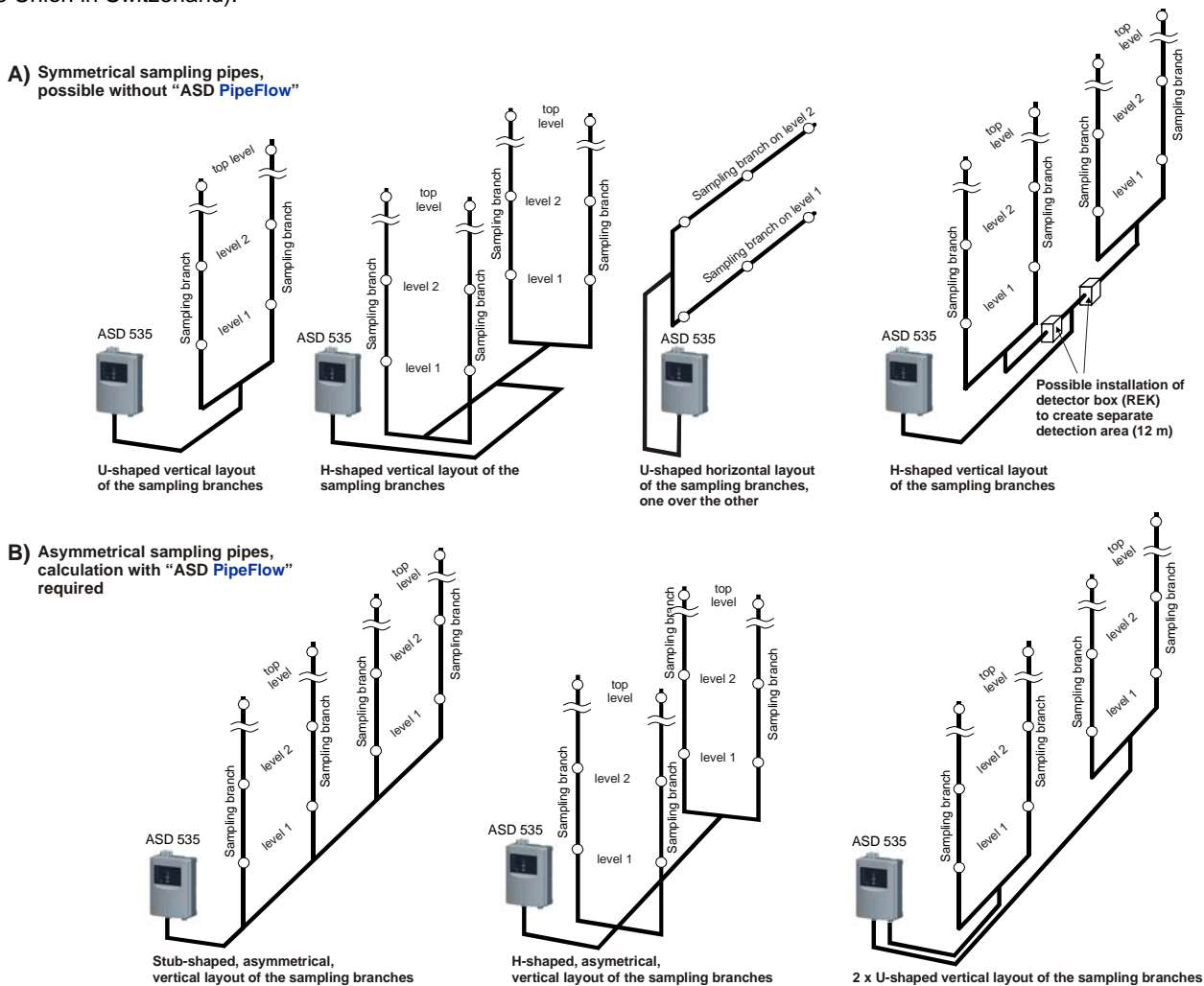



Fig. 11 Examples of sampling pipe layouts in high-rack storage buildings

High-rack storage buildings can be planned with the "ASD PipeFlow" calculation software as well as with the stored system limits as described in Sec. 4.4.4.3 (A11 to C32 and W01 to W48). When planning asymmetrical layouts as in Fig. 11, B), it is imperative that the "ASD PipeFlow" calculation software is used.

In principle, the respective limit values of the “ASD PipeFlow” calculation software apply or the stored system limits as described in Sec. 4.4.4.3 (**A11** to **C32** and **W01** to **W48**). In addition, the limit values in the following table must also be observed and maintained:

Height from ground level 1	max. 6 m
Distance between levels	max. 6 m
Vertical distance of the sampling branches	max. 6 m
For all other values the specifications from the “ASD PipeFlow” calculation or from the tables in Sec. 4.4.4.3 and 4.4.4.4 apply.	

The sampling pipe should be positioned so that the sampling holes take in the air directly from the “gasses” (conveyance side of the high-rack storage building).



Notice

The examples and limit values above are based on the use of the ASD 535. For any possible deviations in the layouts of the sampling pipe, please refer to the relevant country-specific guidelines.

4.5 Equipment monitoring

4.5.1 Equipment monitoring applications

Equipment monitoring applications with ASD 535 are additional to space surveillance. Equipment monitoring directly monitors an object (machine, device or equipment). The following objects can be monitored with the ASD 535:

- Electrics cabinets with or without forced ventilation
- EDP computer systems and cabinets with or without ventilation
- Devices and machines in production technology
- Transmitting and transmission facilities
- Low pressure cupel in the chemical industry (air recirculation), permissible only after consulting with the manufacturer.

4.5.2 Principles of equipment monitoring



Notice

Equipment monitoring is subject to the following principles:

- The country-specific application guidelines must always be adhered to.
- In equipment monitoring it preferable to use Classes A and B compliant with EN 54-20.
- Equipment monitoring applications using the ASD 535 are additional monitoring applications to space surveillance.
- Planning with **the “ASD PipeFlow” calculation software is preferable**. This guarantees optimal detection behaviour and ensures that the technical system limits are optimally utilised. If for any reason the calculation with ASD PipeFlow is not possible, the thresholds as set out in Sec. 4.5.4 must be observed.
- Symmetry is not required for equipment monitoring.
- Unlike space monitoring, which involves individual sampling holes, equipment monitoring involves the use of **sampling fixtures** with several sampling holes.
- The **sampling fixture** is defined as a small pipe entity in the shape of an „I“, „U“, „T“, „H“ or other form with typically 2 to 4 sampling holes.
- The sampling fixtures are arranged in such a way relative to the object that they intake the air outflow (ventilation slot or screen). Ideally the sampling holes are distributed symmetrically on each sampling fixture over the surface of the opening / screen.
- On objects with a high air-flow rate (strong ventilation), the sampling holes can be fitted with SF ABS sampling funnels for optimal smoke detection.
- The systems should be formed in such a way that false alarms are avoided.

4.5.3 Examples of sampling pipe layouts for equipment monitoring

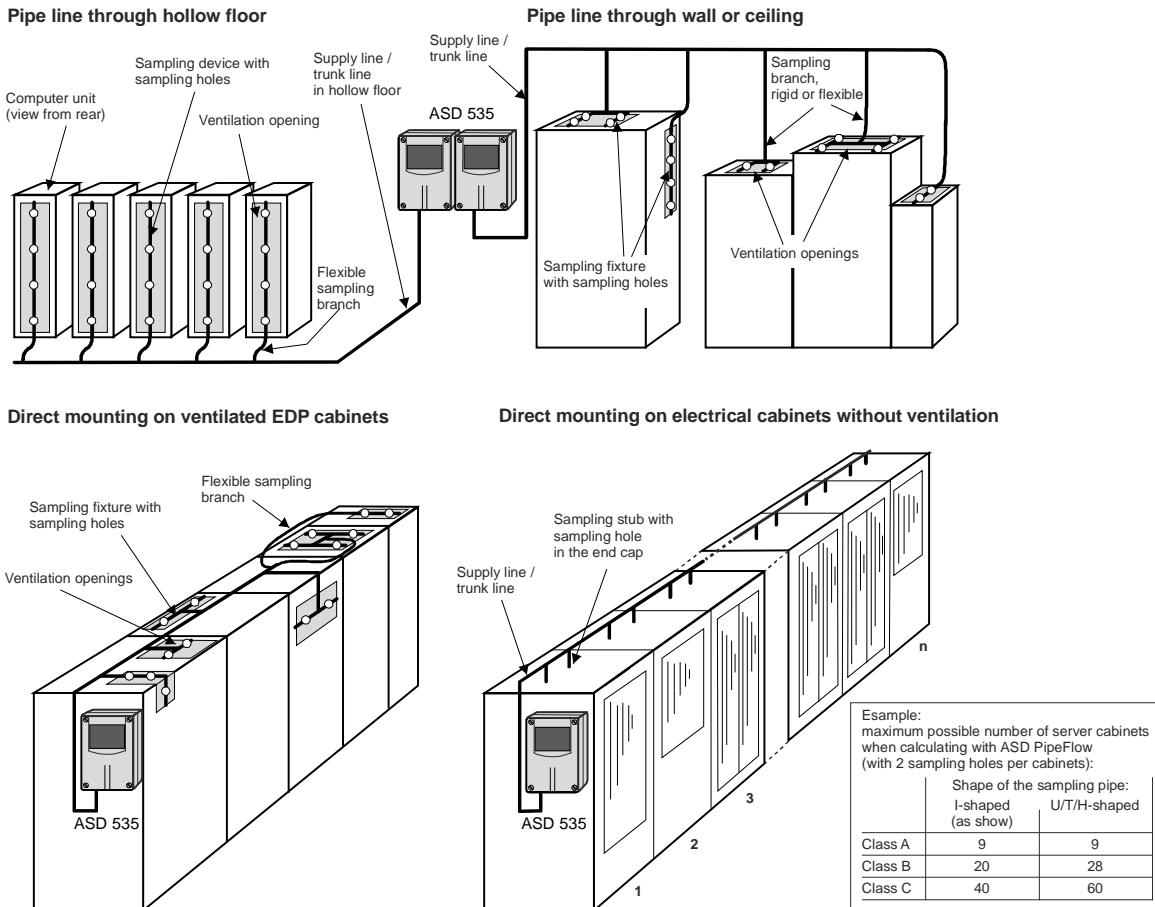

Fig. 12 Equipment monitoring layout variants (examples)

4.5.4 System limits for equipment monitoring

The following limit values for sampling pipe layouts must be observed (per tube input / smoke sensor):

Maximum number of sampling fixtures	1 – 6
Maximum number of devices/cabinets that can be monitored (observe national guidelines)	1 – 5 (– 6)
Farthest sampling point	60 m
Minimum length of the sampling pipe	1 m
Maximum length of the sampling pipe (total)	80 m
Tube Ø of trunk line (inner/outer)	20 / 25 mm
Minimum tube Ø of flexible sampling branch (inner/outer)	16 / 21 mm
Maximum length per flexible sampling branch	3 m
Number of sampling holes per sampling fixture	2 – 4
Minimum number of sampling holes	4
Maximum number of sampling holes (total)	24



Notice

The values in the table above must be strictly observed. Other values may be used only after consulting with the manufacturer.

4.5.4.1 Alarm thresholds for equipment monitoring using sampling fixtures without ASD PipeFlow calculation

When planning without ASD PipeFlow calculation as described in Sec. 4.5.4, the following alarm thresholds (saved on switch positions **X01**, **X02** or **X03**) are to be set by means of the “ASD Config” configuration software based on the total number of sampling holes in **all sampling fixtures (AV)** on the ASD:

When using without duster filter unit FBL/DFU:

Response grade	Alarm threshold (%/m) for total number of sampling holes (<u>without</u> FBL/DFU)					
	4 (1 AV)	5 – 8 (2 AV)	9 – 12 (3 AV)	13 – 16 (4 AV)	17 – 20 (5 AV)	21 – 24 (6 AV)
acc. to EN 54-20, class A	0.1	0.05	0.033	0.024	0.02	---
acc. to EN 54-20, class B	0.29	0.14	0.095	0.07	0.055	0.045
acc. to EN 54-20, class C ①	1.67	0.83	0.55	0.4	0.32	0.25

① In equipment monitoring it preferable to use Classes A and B compliant with EN 54-20.

When using with duster filter unit FBL/DFU:

Response grade	Alarm threshold (%/m) for total number of sampling holes (<u>with</u> FBL/DFU)					
	4 (1 AV)	5 – 8 (2 AV)	9 – 12 (3 AV)	13 – 16 (4 AV)	17 – 20 (5 AV)	21 – 24 (6 AV)
acc. to EN 54-20, class A	0.07	0.035	0.023	---	---	---
acc. to EN 54-20, class B	0.2	0.1	0.065	0.05	0.04	0.03
acc. to EN 54-20, class C ①	1.17	0.58	0.38	0.28	0.22	0.17

① In equipment monitoring it preferable to use Classes A and B compliant with EN 54-20.

4.5.5 Sampling fixtures and sampling holes in equipment monitoring

The size and number of the sampling holes in a **sampling fixture** are based on the size of the ventilation slots of the object. The following approximate values apply:

Size of the ventilation slot (length x width in cm)	Shape of the sampling fixture	Number of sampling holes	Hole diameter (mm)
< 20 x < 15	I-shaped	2	4.5
< 30 x < 15	I-shaped	3	4
< 40 x < 15	I- or T-shaped	4	3.5
< 80 x < 20	T-shaped	4	3.5
< 40 x < 40	U-shaped	4	3.5
> 40 x > 40	H-shaped	4	3.5

or according to „ASD PipeFlow” calculation



Notice

- The sampling fixtures and their sampling holes must be placed directly in front of the airflow of the object.
- The sampling holes must be facing the outflowing air.
- On objects with a high air-flow rate (strong ventilation), the sampling holes should be fitted with SF ABS sampling funnels for optimal smoke detection.
- Symmetry is not required for the sampling fixture.

Below are the system limits for a **direct pipe conveyed** via electrical or server cabinets as shown in Fig. 11. Except for the following specified hole diameters in the upper part of the table (e.g. for system modernisations), the hole diameter and alarm threshold are to be specified by an **„ASD PipeFlow”** calculation:

Electrical cabinet monitoring (as in Fig. 11)	Shape of the sampling pipe	Number of sampling holes	Number of cabinets	Hole diameter (mm)
with internal partitions	I-shaped	12	6	4 x 3,5 4 x 4,0 4 x 4,5
without internal partitions	I-shaped	24	12	8 x 3,5 / 8 x 4,0 8 x 4,5 (only class C possible)
acc. to EN 54-20, class A	I-/U-/T-/H- shaped	18	9	calculation with „ASD PipeFlow”
acc. to EN 54-20, class B	I-shaped	40	20	
	U-/T-/H- shaped	56	28	
acc. to EN 54-20, class C	I-shaped	80	40	
	U-/T-/H- shaped	120	60	

4.6 Two-detector dependency

For 2-detector dependency, systems with two smoke sensors must be used (i.e. ASD 535-2 or ASD 535-4). The layout of the sampling pipe tube network may be single or double as shown in Fig. 13. When monitoring with only one tube network, tube inputs I and II merge before entering the detector housing. The two smoke sensors of the ASD 535 must be independently evaluated (see Sec. 6.6.4.1). **Important:** When monitoring **extinguishing areas**, a **dual layout** of the sampling pipe tube network is required. Country-specific guidelines must be observed.

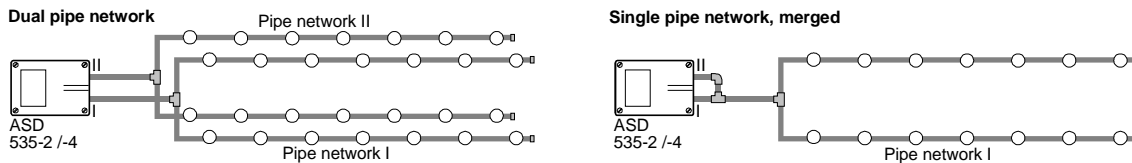

Fig. 13 Two-detector dependency

4.7 Air recirculation

In applications where the sampling holes and detector housing are in different climate zones, it is necessary to recirculate the sampled air in the climate zone of the sampling holes. The “ASD PipeFlow” calculation software must be used to calculate the sampling pipe. The maximum length of the pipe for the air recirculation may be a maximum of 20 m from the detector housing.

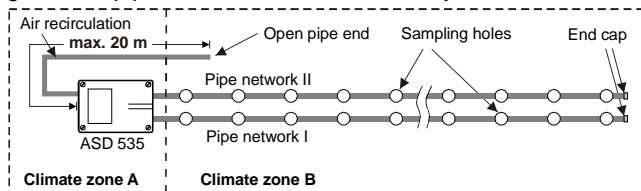

Fig. 14 Air recirculation for differing climate zones

4.8 Settings

The following diagram shows the setting procedure with and without the “ASD PipeFlow” calculation software:

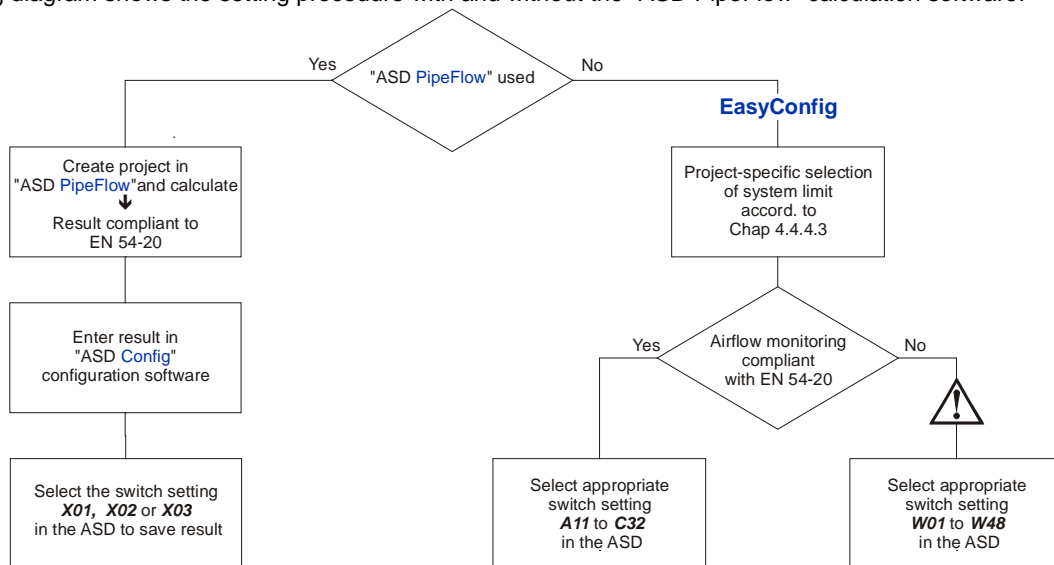

Fig. 15 Workflow of project-specific programming and adjustment



Warning

Switch settings **W01** to **W48** may be used only after consulting with the manufacturer. The configured values they contain concerning airflow monitoring are **not** tested in accordance with EN.

The definitions of the pre-defined settings and the operator structure are found in Sec. 4.4.4.3, 4.4.4.4, 7.2.1 and 8.3.

Depending on the use of the ASD 535, it may be necessary to make adjustments to the airflow monitoring using the “ASD Config” configuration software. These adjustments concern only the size of the monitoring window (pipe breakage / pipe blockage) and the fault delay time (time until a fault is reported due expiry of the monitoring window). Please note and adhere to the following information:



Warning

- Increasing the LS-Ü values ($> \pm 20\%$ / > 300 s) means exceeding the normed EN 54-20 range and should be used only after consulting with the manufacturer.
- The **window size $\pm 20\%$** should in principle **not be undershot**. Smaller window sizes may be set only if at the same time the delay time of the airflow monitoring is increased to at least **10 min**. Due to the very high sensitivity of airflow monitoring when the window size is below $\pm 20\%$ and at the same time the delay time is ≤ 300 s, the risk of false alarms as a result of airflow monitoring faults is increased.



Notice

- In applications with high air turbulence, increasing the delay time and the window size to over $\pm 20\%$ may be necessary in some instances. **Important:** This means exceeding the normed EN 54-20 range and should be used only after consulting with the manufacturer.
- Changing the configuration “**Airflow pipe blockage / pipe breakage On/Off**” is for use under special conditions and may be implemented only after consulting with the manufacturer.

4.9 Electrical installation

4.9.1 Installation cable requirements

The supply line from the FACP to the ASD 535 detector housing is defined by the lines and/or FACP technology in use. Generally, cables with twisted pairs are to be used. For 4-wire and multiwire cables, twin- or quad-twist cables are to be used. Laying voltage supply line and line in one cable is permitted.

A separate wire pair is used for the ASD 535 voltage supply.

The electrical installation is usually performed with commercially available cables. Depending on the country of use, special fire detector cable may be required by the responsible authorities. You should therefore ask the responsible country-specific authorities about the required cable types.

The installation cable must have a minimum wire diameter of 0.8 mm (0.5 mm²). **Please refer to Sec. 4.9.2 for determining the exact maximum cable length and the required cable cross-section.**



Danger

For safety reasons (EN 54) it is necessary to use individual cables for the outbound and return lines for addressable loop technologies.

It is also important **to observe** the **FACP manufacturer's specifications** concerning the maximum **line length, cable type, screening**, etc., of the addressable loop technology used.

Isolation and installation type are also subject to country-specific guidelines and regulations.

Caution: For system monitoring – for terminals “Alarm I”, “Alarm II” and “Fault”, **do not use looped wire** under terminals. Break wire run to provide monitoring of connections.



Danger

The electrical installation of the ASD 535 can normally be performed without screening. Screening of the installation is required wherever EMC influences are to be expected. In the following environments disturbance variables can be expected and the installation must be provided with screening accordingly:

In and around transmitter and radio facilities. Near high-voltage and low-voltage installations with high energy. In areas with EMC field strengths of more than 10 V/m. In cable lines and shafts with high-energy cables. In areas where there are devices and installations charged with high energy (generators, power plants, railway facilities, X-ray equipment etc.). Outside buildings.

If screening is used, the cable screening in the ASD 535 is connected to an additional support terminal. The cable screening must **not** be connected to the minus or **Ground** terminal of the AMB 35.

4.9.2 Determination of the conductor cross-section

Danger

Determination of the conductor cross-section must always be carried out and protocolled. Conductor cross-sections which are too weak can result in malfunctions of the aspirating smoke detector.

Notice

When determining the required conductor cross-section, in addition to the ASD 535 voltage consumption, it is necessary to take into consideration the limit data of the used lines and the FACP technology.

As a rule, the conductor cross-section for the ASD supply is also sufficient for the line. It is nevertheless advisable to calculate the minimum conductor cross-section with the FACP-specific limit data (voltage consumption and voltage drop).

The terminals of the ASD 535 are designed for maximum 2.5 mm². To continue the supply line to a neighbouring ASD, it may thus be necessary to install additional distributor or support terminals. **Important:** Use support terminals only for power supply line.

The current consumption of consumers operated on the open collector outputs must be taken into account when the current is calculated.

To ensure that the ASD 535 functions trouble-free, the conductor cross-section must be measured so that at the end of the electric installation (i.e. at the ASD 535) the maximum required current consumption is still available in all cases.

When determining the conductor cross-section, the highest possible current consumption of the ASD 535 during normal operation (after switching on) is the decisive factor. Due to its circuitry design, the ASD 535 has the highest current consumption at minimum supply voltage, i.e. at 10.5 VDC.

Below are the decisive conductor cross-section values of the ASD 535 (measured at peak fan speed):

• Minimum wire diameter:		0.8 mm (0.5 mm ²)
	12 VDC operation	24 VDC operation
• Maximum current consumption at:	10.5 VDC	18 VDC
- ASD 535-1, ASD in alarm (AI I)	660 mA	390 mA
- ASD 535-2, ASD in alarm (AI I + AI II)	745 mA	450 mA
- ASD 535-3, ASD in alarm (AI I)	695 mA	405 mA
- ASD 535-4, ASD in alarm (AI I + AI II)	820 mA	490 mA
- Additionally with RIM 35 (with 2 x RIM 35 = x 2)	15 mA	10 mA
- Additionally with XLM 35 or SLM 35	20 mA	10 mA
- Additionally with MCM 35	25 mA	15 mA
- Additionally with SIM 35	20 mA	10 mA
• Maximum permitted voltage drop on the installation:	1.5 VDC	6 VDC

Calculation: $A = \frac{I \times L \times 2}{\gamma \times \Delta U}$

I =	Current consumption (in A)	L =	Single line length (in m)
2 =	Factor for return line	γ =	Cu conductivity (57)
		ΔU =	Voltage drop (in V)

Example 1, ASD 535-4, line length 100 m, 12 VDC operation:

Calculation: $A = \frac{0.820 \times 100 \times 2}{57 \times 1.5} = 1.91 \text{ mm}^2 \rightarrow \mathbf{2.0 \text{ mm}^2}$

Example 2, ASD 535-4 with XLM 35, line length 300 m, 24 VDC operation:

Calculation: $A = \frac{0.5 \times 300 \times 2}{57 \times 6} = 0.87 \text{ mm}^2 \rightarrow \mathbf{1.0 \text{ mm}^2}$

4.10 Limitations



Notice

The following limitations apply to the use and application of the ASD 535. For other solutions, please consult the manufacturer.

General information and space monitoring:

- The sampling holes of both tube networks and the detector housing must be located in the same climate zone (pressure and temperature zone). (Sampled air may have to be recirculated to the other climate zone.) Pressure differences between detector housing and sampling pipe (sampling holes) are not permitted.
- If sampling pipes with room-warm air have to be routed through areas in which the temperature may fall below 4°C, the pipe parts in these areas have to be specially installed (possibly by insulating the sampling pipe as specified by the manufacturer).
- Applications with a high level of dust and/or high atmospheric humidity require accessory parts as recommended by the manufacturer, for example: filter box / filter unit, dust trap, water separator or manual ball-cock for sporadic cleaning of the sampling pipe with compressed air (see also Sec. 11).
- The specified maximum tube length must **not** be exceeded.
- Several rooms may be monitored per aspirating smoke detector only if it is permitted by the applicable guideline (e.g. DIN VDE 0833-2 in Germany, Cantonal Fire Insurance Union in Switzerland).
- The two sampling pipes (I and II) may monitor different areas only if they are located in the same climate zone. Country-specific guidelines must be observed in this case (e.g. DIN VDE 0833-2 in Germany, Cantonal Fire Insurance Union in Switzerland).
- When surveillance spaces higher than 16 m, the situation must first be clarified with the manufacturer, the insurance company and, if necessary, the fire brigade (in some cases, larger or higher monitoring areas are possible).
- The sampling holes must be accessible for cleaning in the event of an emergency (possibly cleaning from detector housing with compressed air or under 0 °C with nitrogen).
- The fan has a noise level indicator (possibly mounted on the detector housing in an acoustically insulated cabinet – e.g. sound insulation map case – or side room, see also Sec. 5.4).
- In areas with significant temperature fluctuations of more than 20°C, special adjustments (larger airflow window, longer delay time etc.) may have to be configured for the sampling pipe and on the detector housing.
- In spaces with high ambient temperatures of > 50°C and/or humidity of > 80%, cooling sections may have to be used in the sampling pipe.
- Only those materials listed and approved by the manufacturer may be used when installing the system (component of the device approval according to EN 54-20). Material from other sources may be used only if the manufacturer's written consent has been obtained.
- Ex zones may be monitored **only** with the approval of the manufacturer; this requires the use of special accessory parts (explosion protection). If this is the case, **only** the sampling pipe may be located in the Ex zone. The ASD 535 detector housing must be installed outside the Ex zone in a secure area. Return circulation of the air in the Ex zone (monitoring room) is absolutely required. The accessory parts are installed outside the Ex zone.
- The environmental influences as listed in Sec. 4.11 must be taken into account.

Equipment monitoring (additional):

- See Sec. 4.5

4.11 Environmental influences



Danger

On the basis of tests that have been performed, the ASD 535 can be used in an environment that is within the scope of the type approvals. The environmental conditions as described in Sec. 13 must also be observed. Non-observance can negatively impact proper functioning of the ASD 535.



Notice

For special applications (e.g. in arctic or tropical climates, in ship applications, high-level EMC environments, high impact etc.) please contact the manufacturer of the ASD 535 for empirical values and special application guidelines.

4.12 Use compliant with UL 268 and ULC-S529

For use compliant with **UL 268** and **ULC-S529** the following alarm sensitivity ranges of the used smoke sensors in the ASD 535 must be adhered to.

Special Applications (as specified in the manufacturer's installation instructions)		
SSD 535-1	SSD 535-2	SSD 535-3
0.5 – 10 %/m	0.1 – 10 %/m	0.02 – 10 %/m
0.1527 – 3.1604 %/ft	0.0305 – 3.1604 %/ft	0.0061 – 3.1604 %/ft

Open Area, 0 – 20 m/s (0 – 4000 ft/min) air velocities, 136 m (446 ft) max. overall length of the sampling pipe tube network		
SSD 535-1	SSD 535-2	SSD 535-3
N/A ①	0.1 – 0.3 %/m	0.02 – 0.3 %/m
N/A ①	0.0305 – 0.0915%/ft	0.0061 – 0.0915%/ft

Air duct, 20 m/s (4000 ft/min) maximum air velocity, 10 m (32.8 ft) maximum pipe network length, no smoke dilution		
SSD 535-1	SSD 535-2	SSD 535-3
0.5 – 6 %/m	0.1 – 6 %/m	0.02 – 6 %/m
0.1527 – 1.8683 %/ft	0.0305 – 1.8683 %/ft	0.0061 – 1.8683 %/ft



Notice

① Model SSD 535-1 Smoke Sensor Assembly may not be used in UL and ULC installations for Open Area Protection. Model SSD 535-1 Smoke Sensor Assembly may be used in UL and ULC installations for Air Duct Installations and Special Applications

5 Mounting

5.1 Mounting guidelines



Notice

Material and products. When the system is set up, only the following supplied, approved and listed materials may be used:

- Detector housing, smoke sensors, expansion modules
- Tube materials and fittings for sampling pipe, accessory materials, pipe clamp (according to T 131 194).

Other materials do not conform to EN 54-20 approval and may be used only if the manufacturer's written consent has been obtained.

Installation materials such as cable, intermediate distributors and fastening materials are usually supplied by the customer.

Tools for working with the detector housing. The tools listed below are required for mounting and installation (sorted by the sequence of use in this document):

- | | |
|--|---------------------------------------|
| • Opening the detector housing | Flat-blade screwdriver no. 5 (8 mm) |
| • Removal of pipe plugs | Flat-blade screwdriver no. 2 (4 mm) |
| • Fastening the detector housing | Torx screwdriver T20 |
| • Module holder for expansion modules | Torx screwdriver T15 |
| • Terminals | Flat-blade screwdriver no. 1 (3.5 mm) |
| • Replacing printed circuit boards AMB, ACB, BCB | Torx screwdriver T10 |
| • Replacing aspirating fan unit | Torx screwdriver T15 |

5.2 Dimensioned drawing / drilling plan for detector housing

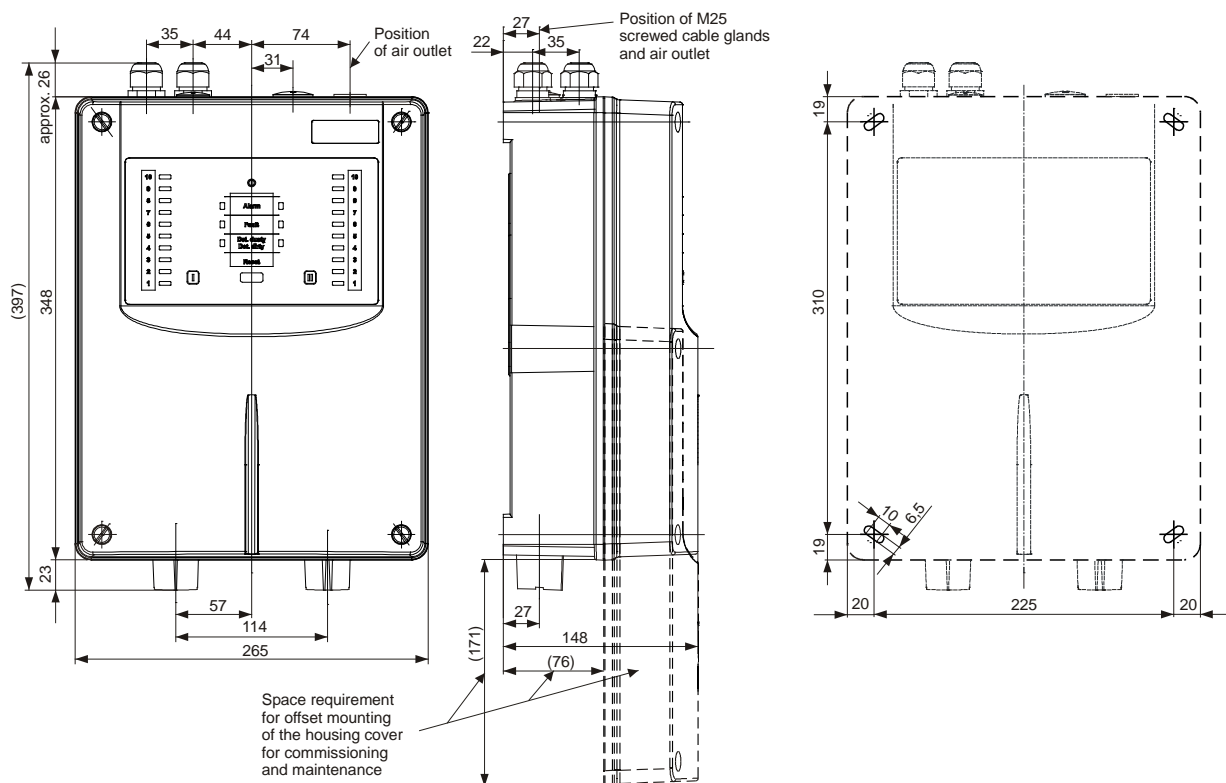

Fig. 16 Dimensioned drawing, ASD 535 detector housing drilling plan

5.3 Material for the sampling pipe



Notice

Tube materials and fittings must satisfy the requirements of at least Class 1131 of **EN 61386-1**. Document **T 131 194** lists materials that meet this standard; it is part of the device approval of the ASD 535 according to EN 54-20.

Other materials do not conform to the EN 54-20 standard and may be used only if the manufacturer's written consent has been obtained and the following conditions are met.

- Compression resistance = at least 125 N (EN 61386-1)
- Shock resistance = at least 0.5 kg, fall height of 100 mm (EN 61386-1)
- Temperature range = at least -15°C to +60°C (EN 61386-1)
- Tube inner diameter = 19 to 22 mm
- Bend radius = at least 30 mm.

The tube material is available as different plastics and metals. The individual plastic tube parts are usually glued. The flexible tube material for equipment monitoring is pluggable. The metal tubes are connected by means of press fittings.

The rigid plastic tubes can be shaped by heating them. The tubes can be painted a different colour, whereby attention must be paid to the chemical compatibility of the paint to the tube.

The following materials are available:

Material	Connection method
PVC (polyvinyl chloride, contains halogen)	Gluing
ABS (acrylonitrile-butadiene styrene, contains no halogen)	Gluing
PA (polyamide, contains no halogen)	Plug-in connection
Copper	Press fitting
Stainless steel	Press fitting



Notice

The two materials that use glues (PVC and ABS) must not be combined, since different adhesives are used.

Transitions from PVC or ABS to PA materials (flexible tube parts) are possible with special adhesive screw junctions.



Danger (see also Sec. 9.5.1)

PVC produces corrosive and toxic gases if burned or improperly disposed of. The use of PVC materials should therefore be limited to where it is expressly permitted by the operator of the installation. In applications where halogen-free plastics are prescribed, ABS or PA materials must be used for laying the sampling pipe. Country-specific guidelines and regulations must be observed.

The adhesives and cleaning agents used for connecting PVC and ABS materials contain solvents and are combustible. For this reason, prior to working with these materials it is imperative to read and observe the safety instructions and information provided by the adhesive supplier.

A list of the available **materials for the sampling pipe** (tubes, fittings etc.) for the ASD 535 is available in a separate document (**T 131 194**).

5.4 Mounting the detector housing



Warning

- Mounting work on the detector housing is best done without fitted smoke sensors.
- The smoke sensors are always installed in the detector housing just when the ASD 535 is commissioned (see Sec. 6.3).
- Depending on the situation (e.g. if there is a long time between mounting and commissioning or if the environment is very dusty due to construction for example), the housing cover should be kept closed until commissioning the device.
- Mounting of the detector housing within hostile environments (according to Australian Standard AS 1603.8) is not allowed.

The detector housing should always be kept in the room to be monitored. If this is not possible, it must be guaranteed that the detection housing is located in a room which has the same air pressure or – for air-conditioned rooms – the same climate and pressure zone. In applications where the sampling pipe and detector housing are mounted in different climate zones, a return sampling pipe to the monitored area is required. The return line can be adapted after removing the air outlet pipe plug on the ASD 535 map case. In this context, see also Sec. 4.6, 5.4.2 and 5.4.3. The maximum length of the return line must not exceed 20 m.

In areas with significant temperature fluctuations of more than 20°C, special adjustments (larger airflow window, longer delay time etc.) may have to be performed for the sampling pipe and on the detector housing. This also applies to temperature differences of more than 20°C between sampling pipe and detector housing.

An easily accessible installation location should be chosen so that the detector housing can be worked on without aids such as ladders and scaffolding. The ideal installation height of the detector housing is about 1.6 m above the ground (top edge of the detector housing).

On the entry side of the sampling pipes a minimum distance of 20 cm from building elements should be maintained (see **Fig. 16**) to enable fastening the housing cover (commissioning and maintenance work). On the entry side of the supply cable, 10 cm distance is sufficient.

When determining a location for the detector housing, take into account that the noise caused by the fan may in some instances be disturbing. If no suitable location is available for the detector housing, it may be necessary to mount it in an acoustically insulated cabinet (e.g. ASD sound insulation map case). If air recirculation in the same climate zone as the sampling pipe is necessary, it can be implemented by means of a tube piece out of the acoustically insulated cabinet. The pipe piece exiting from the acoustically insulated cabinet (transition) must be properly sealed. When using the ASD sound insulation map case, an M32 cable screw union is used for the transition. Contact the manufacturer for more information about the ASD sound insulation map case.

5.4.1 Opening and closing the detector housing



Warning about opening and closing

- To open the detector housing, use a **flat-blade screwdriver no. 5** (8 mm). Smaller flat-blade screwdrivers may damage the material of the rotary snap locks.
- To use the **rotary snap locks**, **press firmly** with the screwdriver toward the map case base and then **turn 90°**. The position of the lock slit shows the current state (see **Fig. 17**):
 - ⇒ approx. 45° angled toward detector housing corner = closed
 - ⇒ approx. 45° angled toward detector housing edge = open
 The rotary snap locks must snap into place.
- The **housing cover** (control unit) is connected to the **Main Board** by a **flat cable**. Make sure that when the housing cover is lifted away the flat cable does not become damaged.

Opening / closing

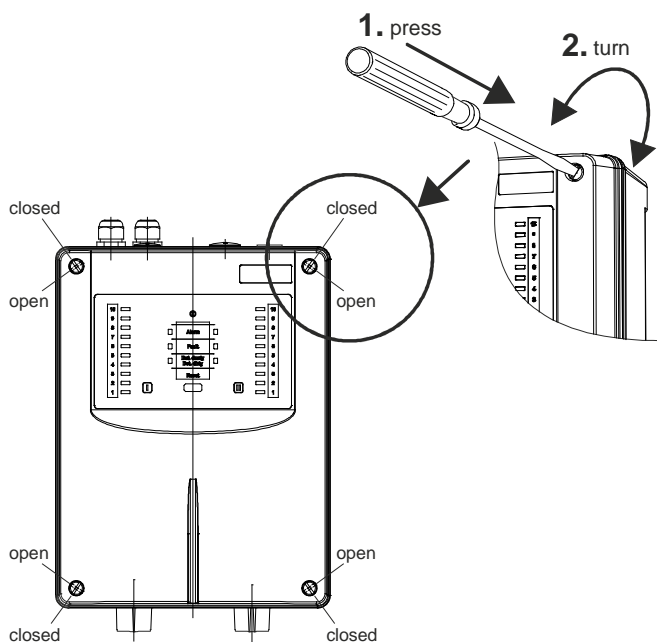

Locking

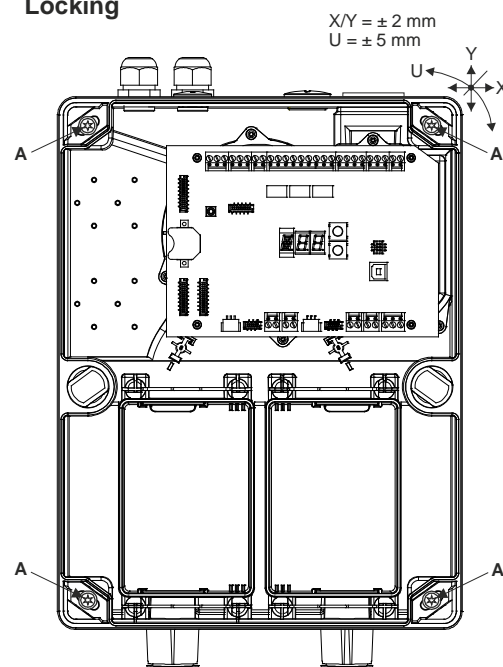

Fig. 17 Opening, closing and fastening the detector housing

After the detector housing is open, the four mounting holes in the housing base are accessible. To facilitate mounting work, remove the entire housing cover of the detector housing (including control unit). To do that, pull off the 10-pin flat cable connector from the AMB 35 **Main Board**.

The detector housing is fastened with the four supplied Torx wood screws (\varnothing 4.5 x 35 mm) and the four U-washers (\varnothing 4.3/12 x 1 mm), "A". Use a **Torx T20 screwdriver** to insert and tighten the screws.

The positions of the fastening holes are seen in dimensioned drawing **Fig. 16**. When fastening to masonry, the supplied S6 dowels are used.



Notice

When mounting several ASD 535 units next to each other, it is important to ensure that the mounting holes are **drilled precisely**. The device can be moved a maximum of ± 2 mm horizontally and vertically to correct the mounting position. A rotation correction of approx. ± 5 mm is possible.

5.4.2 Mounting positions of the detector housing

In principle the detector housing can be mounted in the X, Y or Z axis. Because of the indicator elements labelling, however, mounting in the Y axis is advisable (vertical, control unit up). The sampling pipes are then inserted into the detector housing from below. This makes it easier to conduct pipes to accessory parts such as filter box / filter unit and water separators, which, for physical reasons, should always be below the ASD detector housing. If introducing the sampling pipes into the detector housing from above is unavoidable, the detector housing can be turned 180° and mounted (control unit down). So that the control unit labelling is not upside down, the labelling strips of the control unit can be turned accordingly (see Sec. 5.4.4).

The allocation of the tube networks to the smoke sensors is permanently preset and is recognisable by the identification (ribs) on the tube inputs (I and II). To prevent dirt from entering, the detector housing is delivered with fitted pipe plugs (tube network I and II entries). Similarly, all cable screw unions are closed. The pipe plug is removed on entry I for ASD 535-1 and -3 and on entry II for ASD 535-2 and -4. For ASD 535-1 and -3 with only one tube network, the pipe plug on entry II is not removed. If there is a return sampling pipe in the monitored area, it can be directly connected to the detector housing in place of the air outlet pipe plugs.

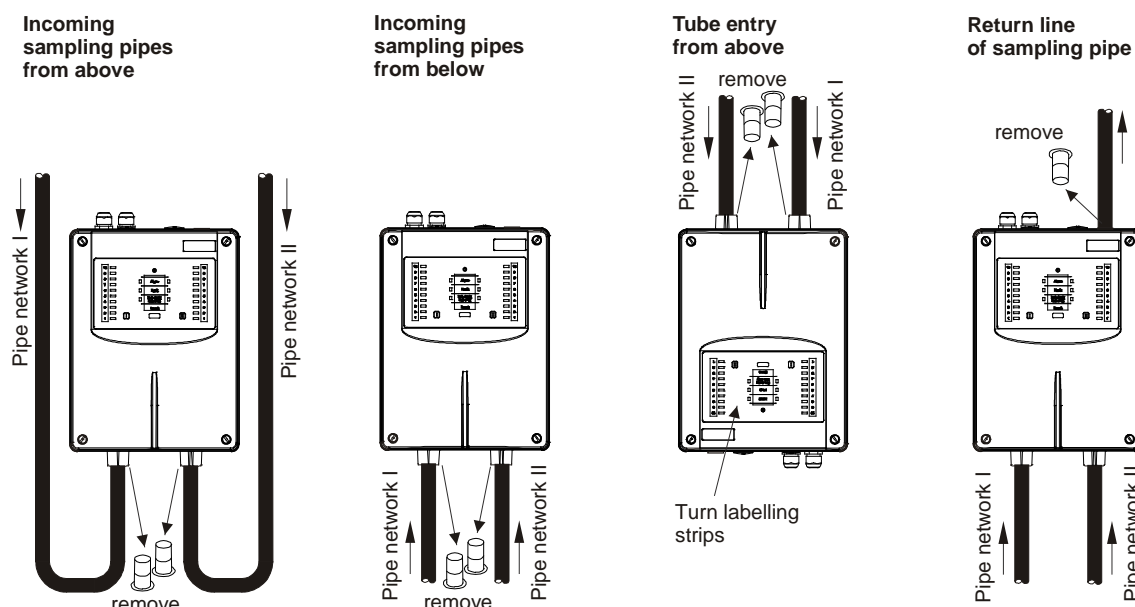

Fig. 18 Mounting position and pipe entries on the detector housing



Warning about pipe entries

- The entry openings in the detector housing are designed so that the sampling pipe only has to be inserted (conical opening). Using an adhesive agent on the sampling pipe should be done only in special cases and after consulting with the manufacturer.
- On the ASD 535-1 and ASD 535-3 the pipe plug must remain on entry II.
- The air outlet pipe plug (with openings) may be fitted only in the air outlet opening.
- The pipe plugs must not be glued in the ASD map case (connector).

5.4.3 Removal of the air outlet pipe plug

Insert the blade of a **flat-blade screwdriver no. 2** (4 mm) into one of the side recesses of the air outlet pipe plug. A slight prying movement toward the ASD housing releases the pipe plug.

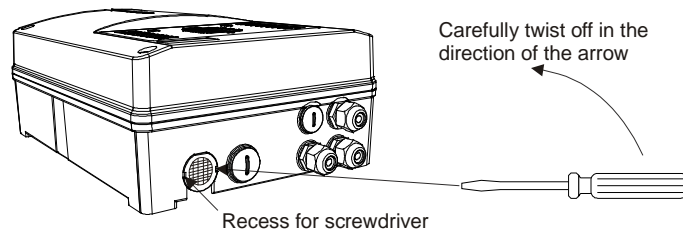

Fig. 19 Removal of the air outlet pipe plug

5.4.4 Turning the labelling strips

To turn the labelling strips, open the detector housing and completely remove the cover from the device (undo the flat cable).

Depending on the device version, there is a different number of labelling strips printed on both sides in the control unit:

- ASD 535-1 = 1 x "A"
- ASD 535-2 = 1 x "A"
- ASD 535-3 = 1 x "A" and 1 x "B"
- ASD 535-4 = 1 x "A" and 2 x "B"

The labelling strips can be pulled out of the control unit by their tabs and after turning over inserted again into the holder.

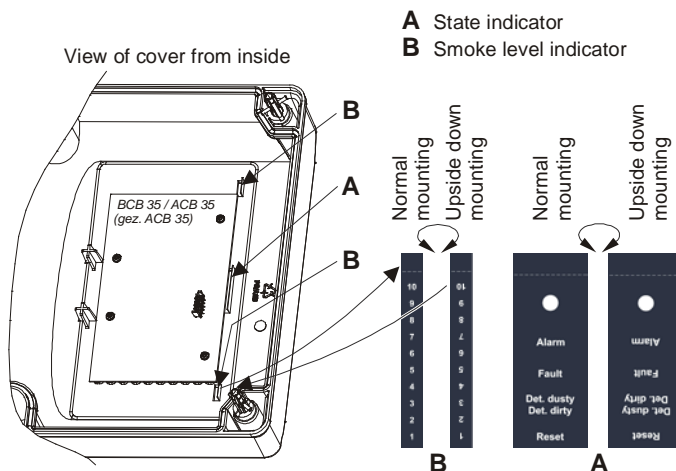

Fig. 20 Turning the labelling strips

5.5 Mounting sampling pipe

5.5.1 General information

Mounting and installation are to be carried out based on the section “Planning” in this document. Deviating from the layout of the sampling pipe and sampling holes (also outside the limits calculated with “ASD PipeFlow”) is permissible only with the consent of the manufacturer.

The sampling pipe can be hard PVC or halogen-free ABS material, depending on requirements. In special applications (e.g. in an extremely corrosive environment) other pipe materials may be used subject to the specifications in Sec. 5.3.



Warning about pipe installation / modification

The performance of this system is dependent upon the sampling pipe. Any extensions or modifications to the designed installation may cause improper operation. The operational effects of such changes shall be verified. Section 4 (planning) must be considered in any case. The Calculation software “ASD PipeFlow” is available from the manufacturer.

5.5.2 Mounting with PVC tubes and fittings

As a rule, when the installation operator does not demand halogen-free installation, sampling pipe can be laid out with hard PVC tubing. When PVC tube material is installed, the individual tube parts are glued together with a special PVC glue (e.g. Tangit for PVC). The glue manufacturer’s instructions must be followed. Before gluing, use household paper to remove dust and grease deposits from the surfaces to be glued (do not use textile cloths). If the tube parts are very dirty, a cleaning agent specified by the glue manufacturer may have to be used.



Danger

The adhesives and cleaning agents used for connecting PVC materials contain solvents and are combustible. For this reason, prior to working with these materials it is imperative to read and observe the safety instructions and information provided by the adhesive supplier.



Notice

The two glueable materials – PVC and ABS – must not be combined, since different adhesives are used.

5.5.3 Mounting with ABS tubes and fittings

If required, halogen-free ABS material can be used for the sampling pipe. When ABS pipe material is installed, the individual tube parts are glued together with a special ABS glue (e.g. Tangit for ABS). The glue manufacturer’s instructions must be followed. Before gluing, use household paper to remove dust and grease deposits from the surfaces to be glued (do not use textile cloths). If the tube parts are very dirty, a cleaning agent specified by the glue manufacturer may have to be used.



Danger

The adhesives and cleaning agents used for connecting ABS materials contain solvents and are combustible. For this reason, prior to working with these materials it is imperative to read and observe the safety instructions and information provided by the adhesive supplier.



Notice

The two glueable materials – PVC and ABS – must not be combined, since different adhesives are used.

5.5.4 Mounting with metal pipes and fittings

Metal tubes (copper, stainless steel) are connected using press fittings according to the manufacturer’s instructions. For this purpose a special press tool can be obtained from the manufacturer on loan.

5.5.5 Linear expansion

Due to the large linear temperature expansion coefficient of plastics, special attention should be given to linear expansion (extensions and shortenings) of the sampling tube. An increase in temperature causes lengthening; a decrease in temperature causes the tube to become shorter. The importance of taking linear expansion into account increases as the temperature at the time of installation deviates from the usual operating temperature.

Linear expansion can be calculated as follows:

Calculation: $\Delta L = L \times \Delta T \times \alpha$

ΔL = Linear expansion in mm
 L = Length in meters of the sampling pipe between two fixed points
 ΔT = Temperature change in °C
 α = Linear expansion coefficient in mm/m°C
 for **PVC** = 0.08
 for **ABS** = 0.10

Example: sampling pipe length 20 m, expected temperature change 10°C, material PVC:

Calculation: $\Delta L = 20 \times 10 \times 0.08 = 16 \text{ mm}$



Notice

For straight layout the linear expansion can be up to **176 mm** over the total sampling pipe length (110 m) within the permitted temperature fluctuation range (20°C). It must therefore be ensured that the sampling pipe can “work” (slide) in the clips and fastening clamps. A distance of 200 mm (0.2 m) should be maintained between the last clip or fastening clamp to the end cap.

5.5.6 Mounting the sampling pipe

Notice

When mounting the sampling pipe, the points below must be observed and adhered to (see Sec. 5.5.5).

- Clips and pipe clamps at 1 m intervals are used to fasten the sampling pipe.
- The tubes must be cut with a pipe cutter to required lengths. In doing so, ensure that the cut is at a right-angle to the tube axis. Any projecting burrs must be removed (Fig. 21).
- The ends of the individual tube pieces are to be slightly angled with a suitable tool, e.g. slightly bevel with a pipe peeler (Fig. 21).
- The individual pipe sections are connected to each other with fittings. Depending on the used tube material, gluing as described in Sec. 5.5.2 and 5.5.3 or pressing as described in Sec. 5.5.4 is used. The tubes are pushed into the fittings to the stop (Fig. 22).
- The connection points must be absolutely sealed to prevent the wrong air from entering.
- For vertically arranged sampling pipe or parts thereof (e.g. in a riser or high-rack storage building) make certain that the tubes cannot slide down (fasten clips directly under fittings as shown in Fig. 23).
- The sampling pipe must be fastened so that the tube can “work” in the clips (linear expansion, see Sec. 5.5.5).
- Beginning at the branching points of the sampling pipe, a distance of at least 0.2 m must be maintained from the T-piece to the clips (Fig. 24).
- For changes of direction in space surveillance installations, it is advisable to use 90° bends rather than 90° angles (Fig. 24). See Sec. 4.4.2.
- When using flush mounting or in false ceilings, it must be ensured that the tubes are not able to vibrate.
- How the tubes are laid out – especially for flush mounting – must be precisely entered in the dimensional data in the installation plans.

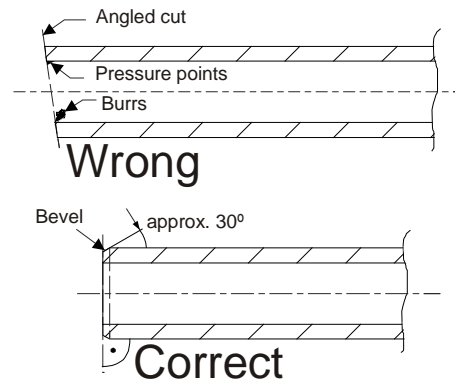

Fig. 21 Cutting the tubes

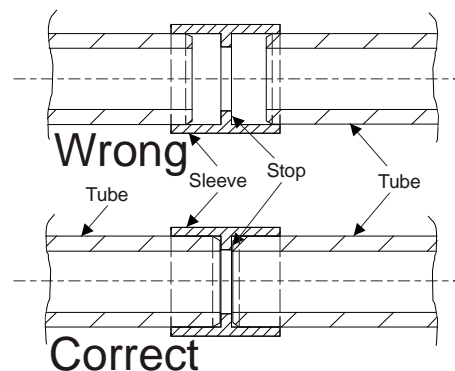

Fig. 22 Joining the tubes

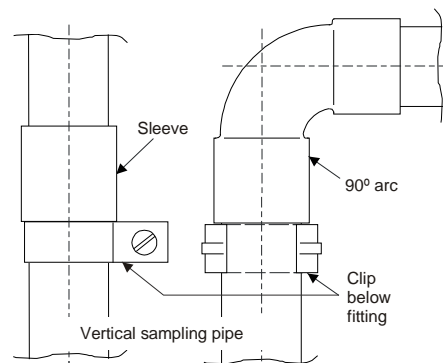

Fig. 23 Vertical sampling pipe

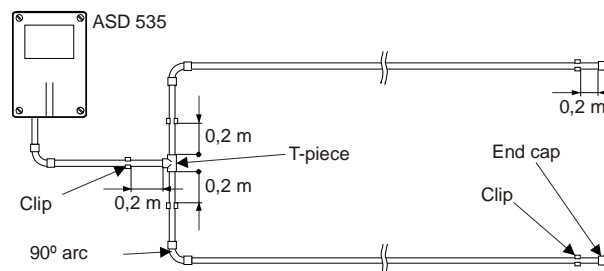

Fig. 24 90° bend, branching point

5.5.7 Mounting for equipment monitoring

When mounting equipment-monitoring systems (EDP installations, electrical cabinets etc.), plastic tube materials are always to be used. Further, the same guidelines as described in Sec. 5.5.6 apply.

All air outlet openings of the monitoring devices have to be used for equipment monitoring. Please note that an ASD 535 can be fitted with a maximum of six sampling fixtures.

Whenever possible, sampling pipe and detector housing are always fastened directly to the object to be monitored.

5.5.7.1 Screw-free fastening of the sampling pipe

For screw-free fastening of sampling pipe parts (sampling fixtures) the click pipe clamps are used. This makes it possible to quickly remove the sampling fixture or the sampling pipe during maintenance work on the monitored objects.

The click pipe clamps are screwed onto the support rails by means of threaded plates.

The support rails are best fastened at a right angle to the pipe axis to ensure precise positioning of the sampling pipe (sampling fixture).

Double-sided adhesive tape is used to fasten the support rails in the desired position on the object (Fig. 25).

Prior to using the double-sided adhesive tape, the adhesion surfaces should be cleaned with a **non-aggressive** cleaning agent (e.g. soap suds or similar).

Using a cable binder instead of the double-sided adhesive tape is also possible.

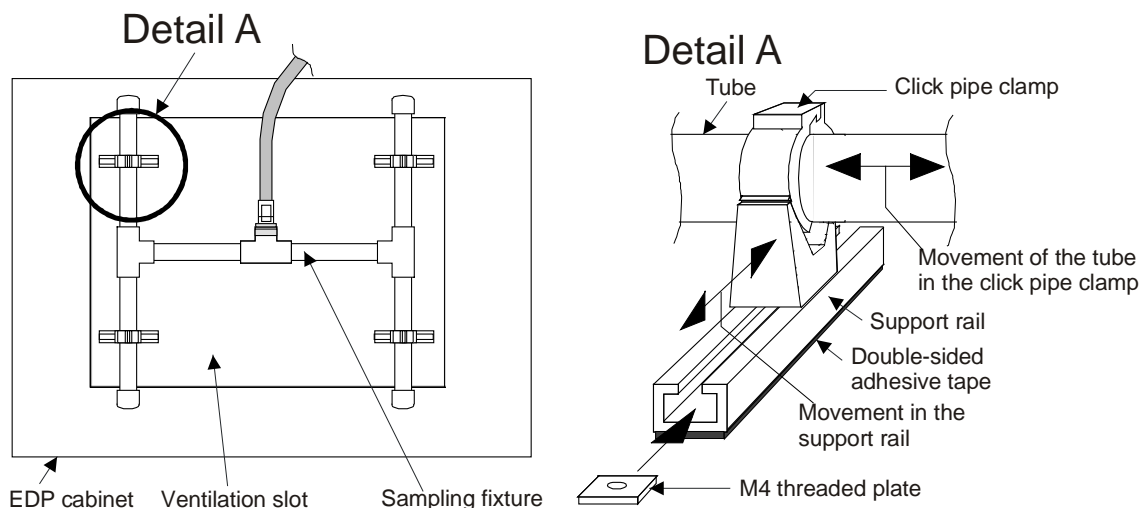

Fig. 25 Screw-free fastening of a sampling fixture

5.5.7.2 Transition to flexible tube

For equipment monitoring, the transition from rigid to flexible tube can be done in principle using any kind of fitting. **Fig. 26** shows the parts that can be used.

For a rigid sampling pipe made of **PVC**, a **PVC threaded ring** with M20 internal thread is glued into the exit side of the fitting. The M20 quick-release coupling is screwed into the threaded ring for the flexible tube.

If the rigid sampling pipe is made of **halogen-free ABS**, the procedure is identical to that for PVC. Instead of the PVC threaded ring, however, a suitable **threaded ring made of ABS** is used.

The flexible tube can be easily snapped into the quick-release coupling, and for maintenance work it can be easily snapped out.



Warning

It is imperative to implement the interfaces of the flexible tube “cleanly” so that the sealing ring does not become damaged in the quick-release coupling.

When clicking in the flexible tube, make sure that the tube and quick-release coupling are pressed well against each other to prevent wrong air from being sucked in.

For transitions from flexible tubes to sampling fixtures, proceed in the reverse order as described above.

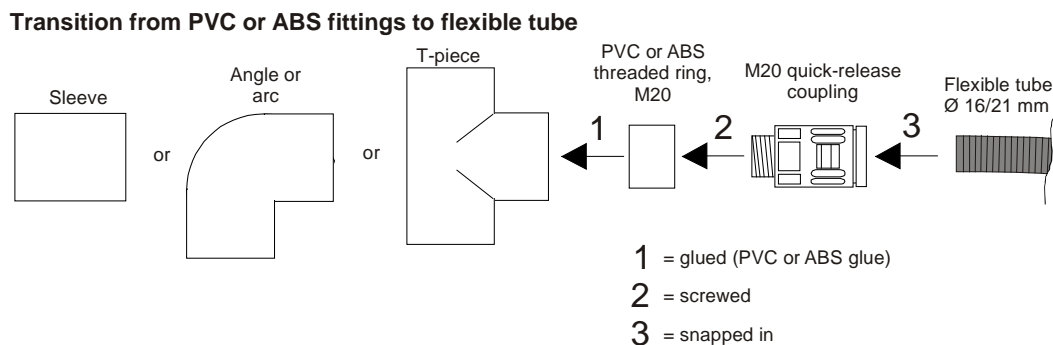

Fig. 26 Transition from fitting to flexible tube

5.5.8 Making the sampling holes

The hole diameters of the sampling holes have to be determined and made by the customer as described in Sec. 4.4.4.5 and the specifications of the “ASD PipeFlow” calculation software or according to Sec. 4.5.5.

The sampling holes must be drilled cleanly so that no burrs or pressure points result. Use “new” drills with correctly ground surfaces (Fig. 27).

Whistling noises are a sign that the holes are not clean. The holes must then be re-drilled or deburred.

For space surveillance, the sequence of the hole diameters as per Sec. 4.4.4.5 and the specifications of the “ASD PipeFlow” calculation software must be strictly adhered to.

If required, the sampling holes can be realized by means of the special “sampling hole clips” (see Sec. 5.5.9).

For equipment monitoring the sampling holes are drilled in the sampling fixture. The sampling holes are drilled in the sampling fixture so that they face the air outlet of the object to be monitored. If required, these sampling holes can be fitted with sampling funnels (Sec. 5.5.10).

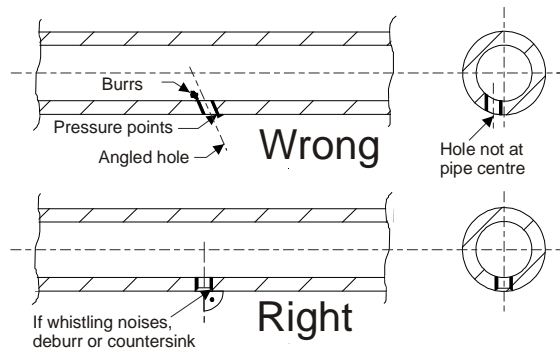

Fig. 27 Making the sampling holes

5.5.9 Mounting maintenance and sampling hole clips

Possible only with plastic tubes (PVC/ABS)!

At each required position a hole of Ø 8.5 mm is made in the sampling pipe (uniform Ø). The holes are made at a right angle to the centre of the pipe axis (as shown in Fig. 27).

The sampling hole clips are available in various sizes (Ø 2.0 / 2.5 / 3.0 / 3.5 / 4.0 / 4.5 / 5.0 / 5.5 / 6.0 / 6.5 / 7.0 mm). For determining the required sampling hole clips, refer to Sec. 4.4.4.5 and the specifications of the “ASD PipeFlow” calculation software or Sec. 4.5.5.

The sampling hole clips and the maintenance clips are clipped onto the sampling tube so that they snap onto the 8.5 mm hole (Fig. 28).

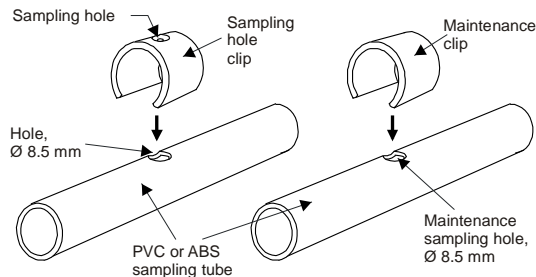

Fig. 28 Mounting clips

5.5.10 Mounting the sampling funnel

Possible only with plastic tubes (PVC/ABS)!

For equipment monitoring objects with a high air flow rate (strong ventilation), the sampling holes can be fitted with funnels for optimal detection of smoke.

If forced ventilation is used in rooms and/or for equipment, the use of sampling funnels is imperative.

The sampling funnels are fastened to the tube of the sampling fixture and adjusted (Sec. 4.5.5) on the previously drilled sampling holes as described in Fig. 29.

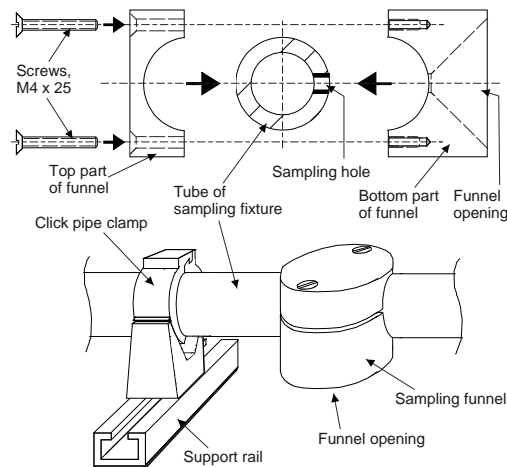

Fig. 29 Using sampling funnels

5.5.11 Mounting sampling stubs for the ceiling duct

Possible only with plastic tubes (PVC/ABS)!

The required parts of a sampling stub for the ceiling duct are shown in **Fig. 30**.

A T-piece is built into the sampling pipe at the required point.

The assembly sequence is performed as indicated by the numbering **1 to 8**.

The size of the sampling hole (8) is based on the specification in Sec. 4.4.4.5 and/or the specifications of the “ASD PipeFlow” calculation software.



Warning

It is imperative to implement the interfaces of the flexible tube “cleanly” so that the sealing ring does not become damaged in the quick-release coupling.

When clicking in the flexible tube, make sure that the tube and quick-release coupling are pressed well against each other to prevent wrong air from being sucked in.

The maximum length of the flexible tube must not exceed **1.5 m**.

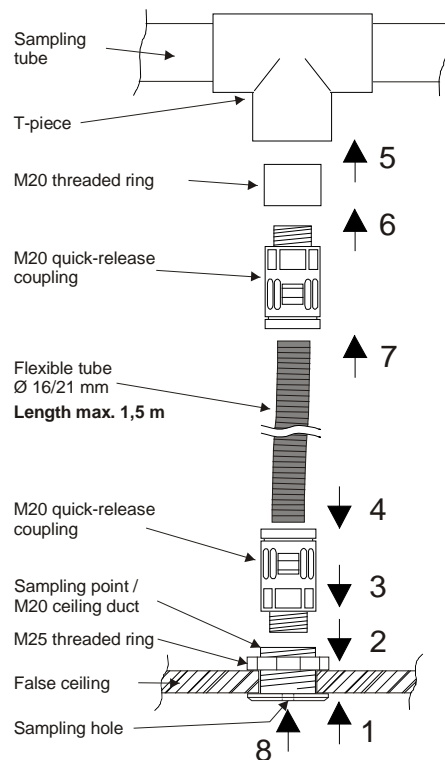

Fig. 30 Mounting the ceiling duct

5.5.12 Mounting filter box, filter unit, dust trap, dust separator, water separator

Applications with an extremely high level of dust and/or dirt, extreme temperature ranges and/or atmospheric humidity outside the specified limit values require the use of accessory parts as recommended by the manufacturer. For example:

- Filter box / filter unit;
- Dust trap;
- Dust separator;
- Water separator;
- Manual ball-cock for sporadic cleaning of the sampling pipe with compressed air;
- Automatic blow-out device.



Notice

The following rules must be adhered to when using accessory parts:

- The use of a filter box and/or filter unit by itself is possible.
- The water separator, dust separator and the dust trap should always be used in conjunction with a filter box and/or filter unit.
- An automatic blow-out device should be used in combination with a dust separator or a dust trap and a filter box and/or filter unit.
- Filter box / filter unit, dust trap, dust separator and water separator must always be mounted under the detector housing. The water separator or dust separator must be located at the lowest point (water drain). The specified minimum dimensions (0.5 m) must be adhered to.
- The mounting positions of water separator, dust trap and dust separator must be observed as shown in Fig. 31.

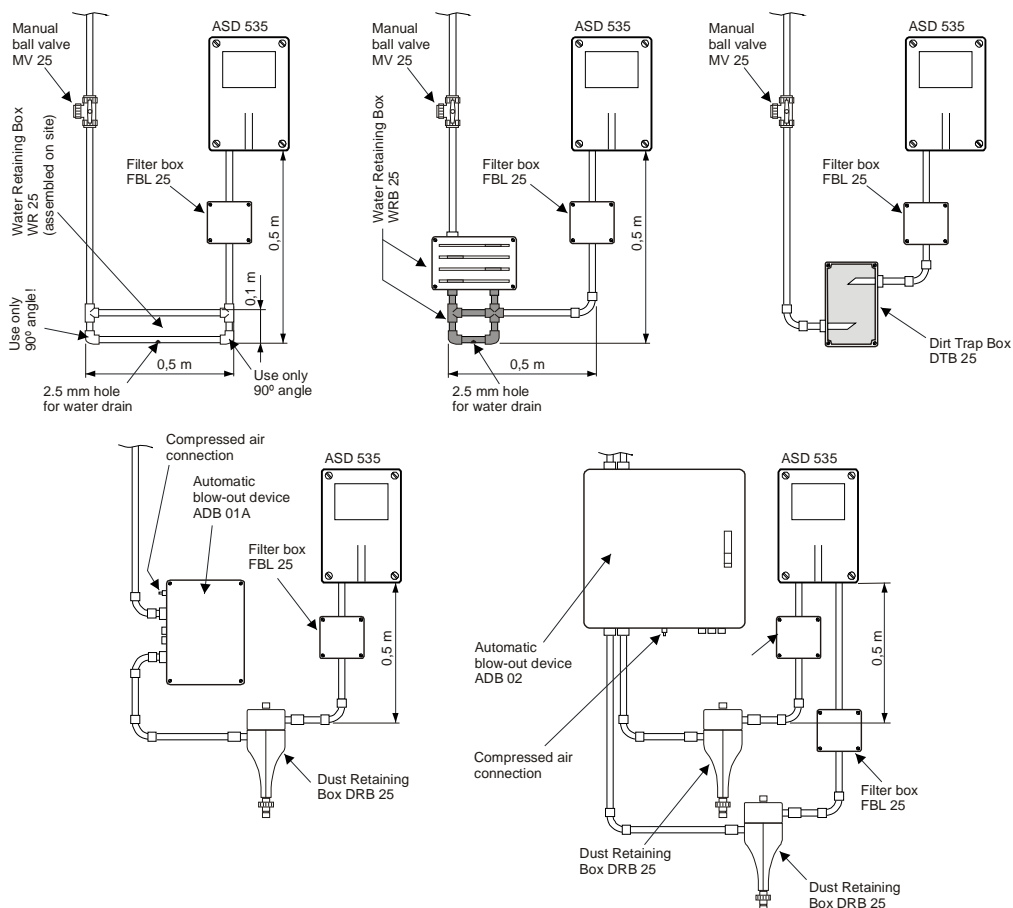

Fig. 31 Mounting accessory parts

6 Installation

6.1 Regulations



Danger

The electrical installation is to be carried out in accordance with the applicable country-specific regulations, standards and guidelines. Likewise, the local provisions must also be observed.



Notice

Besides country-specific regulations and guidelines, the specifications concerning requirements for installation cable and conductor cross-section as described in Sec. 4.9 must be observed and implemented.

6.2 Cable entry

To facilitate installation work, remove the entire housing cover of the detector housing (including control unit). To do that, pull off the 10-pin flat cable connector from the AMB 35 [Main Board](#).



Danger

The voltage must be disconnected for all connection and wiring work on the ASD 535.

There are three M20 cable screw unions in the detector housing for the electrical installation. If needed, two reserve holes (blind plugs) can be fitted with two more cable screw unions (1 x M20, 1 x M25).

The cable screw unions are suitable for cable with an external diameter of 5 to 12 mm (M20) or 9 to 18 mm (M25).



Notice

- When the device is delivered, the cable screw unions are closed with a dust protection insert, which has to be removed before introducing the cable. The dust protection inserts are only for preventing dust and dirt from entering when the device is mounted and provide no mechanical protection. Cable screw unions which are not used must be replaced with blind plugs (mounting set) in order to maintain the IP 54 protection class.
- **Use in compliance with UL 268:** When using the ASD 535 in compliance with UL 268, special 1/2" and 3/4" cable screw unions are to be used (customer-side). To be able to use them in the ASD map case, the existing M20 and M25 screw-junction pieces must be removed and replaced by 1/2" M20 adapters and 3/4" M25 adapters. The adapters are available from the manufacturer in the **AD US M-Inch** range of accessories.

6.3 Deploying smoke sensors

Smoke sensors are not fitted when the ASD 535 is delivered. They are application specific (according to required sensitivity range), purchased from the manufacturer and installed after the detector housing is mounted. In this context, see also Sec. 1.5.



Warning when deploying smoke sensors

- The smoke sensors should always be removed from their protective packaging just before deployment in the detector housing.
- Depending on the situation (e.g. if there is a long time between mounting and commissioning or if the environment is very dusty due, for example, to construction), the smoke sensors should be installed just before commissioning the ASD 535.
- Before installing the smoke sensors, check that the protective screens against insects are properly fitted to the air inlet and outlet in the smoke sensor chambers.
- The smoke sensor chamber must be absolutely free of dirt and dust. Any waste or other materials resulting from mounting the detector housing must be removed.

The installation position of the smoke sensors depends on the particular smoke sensor chamber (I or II). The installation position is always such that the connectors of the smoke sensors are oriented toward the outside of the ASD map case. Incorrect installation positioning is prevented by the anti-twist rib on the smoke sensor housing.

The smoke sensors are fastened with the two lock clamps in the ASD map case. The flat cable delivered with the smoke sensor is connected to the smoke sensor (big flat cable connector) and to the AMB 35 Main Board (small flat cable connector).

The insect protection screens and lock clamps are not fitted to smoke sensor chamber II on the ASD 535-1 and ASD 535-3 (only one smoke sensor). Instead of using the insect protection screens, the air channels are closed. Smoke sensor chamber II remains open for operation.

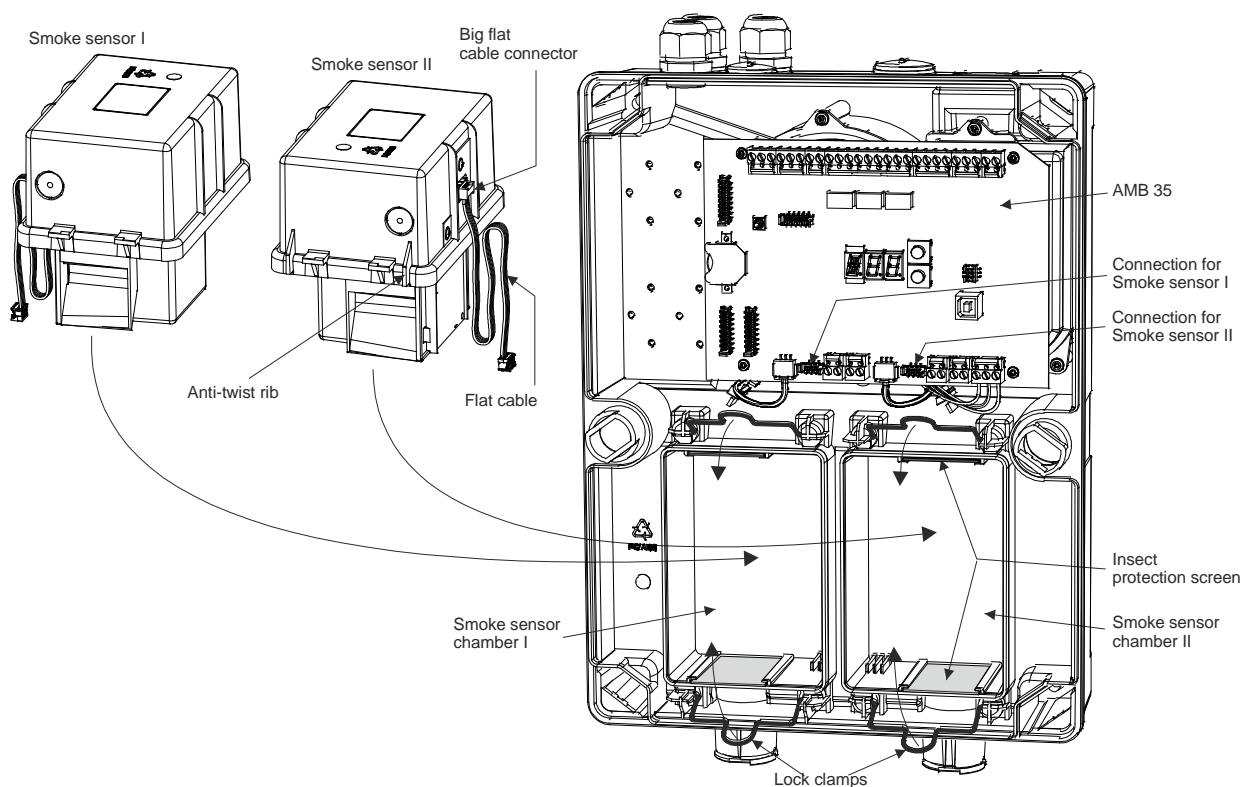

Fig. 32 Deploying the smoke sensors

6.4 Installing expansion modules XLM 35, SLM 35, RIM 35, MCM 35, SIM 35

There are four expansion slots for equipping the detector housing with the optional expansion modules. Because of the module-based assignment of the flat cable connectors on the AMB 35 [Main Board](#) (see Sec. 3.2, [Fig. 5](#)) we recommend the arrangement as shown in [Fig. 33](#).

Each module set has a module holder, mounting screws and the connection cable (flat cable) for connecting to the AMB 35. A **Torx T15 screwdriver** is used to tighten the mounting screws. The module can be removed from the holder for mounting in the detector housing and for the subsequent electrical installation.

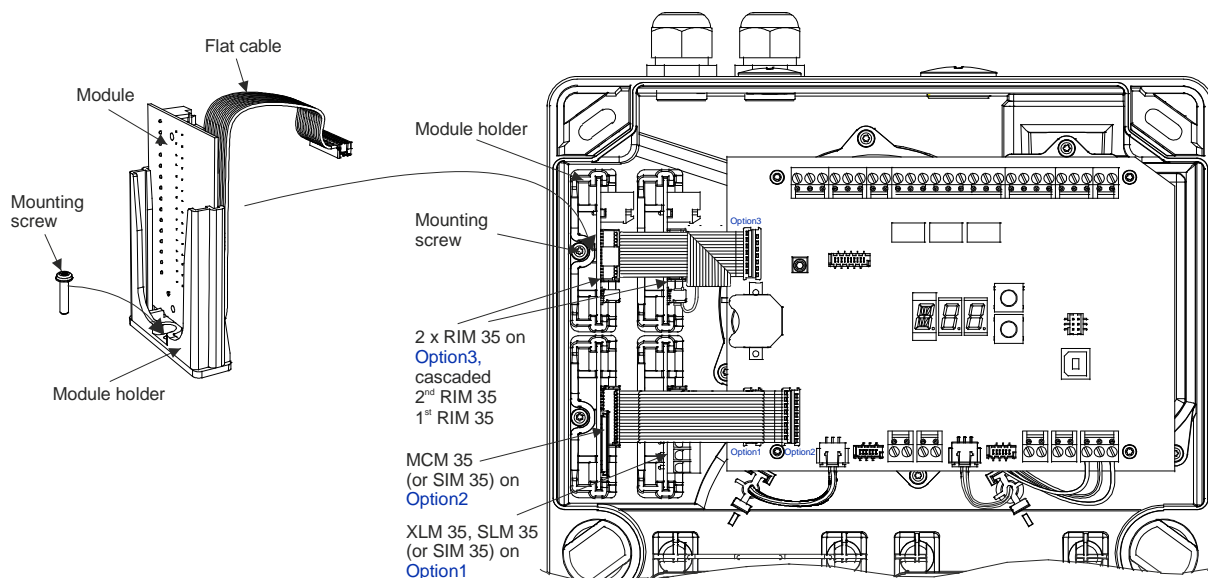

Fig. 33 Installing expansion modules



Notice

The expansion modules are automatically detected when the device is switched on, from which point they are monitored and functional. The MCM 35 begins logging data as soon as the [SD memory card](#) is inserted (approx. after 10 s; indicated by the flashing red LED on the MCM). To read out the [SD memory card](#) or when subsequently removing an expansion module (e.g. if not used), the expansion module must first be logged off via operation on the AMB 35 [Main Board](#) (switch setting **o**, see Sec. 7.3.7).

When installing modules other than XLM, SLM, RIM, MCM or SIM, the UMS 35 universal module holder is available. This is fastened in the detector housing instead of the above described module holder and requires two expansion slots one above the other (directly next to the AMB 35). The UMS 35 consists of an angled sheet metal plate with various fastening options for expansion modules.

6.5 Electrical connection

The electrical connection is implemented by means of plug-in screw terminals. A **flat-blade screwdriver no. 1** (3.5 mm) is used to tighten the screw terminals. Individual terminal blocks are built on for supply voltage, relay contacts, inputs, outputs, etc.



Danger

- Inside the detector housing the lines should be conducted the shortest possible path to the terminals. Reserve loops via the [Main Board](#) are to be avoided (EMC).
- **Caution:** For system monitoring – for terminals “**Alarm I**”, “**Alarm II**” and “**Fault**”, **do not use looped wire** under terminals. Break wire run to provide monitoring of connections.

6.5.1 Terminal assignment of AMB 35 Main Board

AMB terminal	Signal		Wiring
1	+10.5 to +30 VDC (UL/FM = 12.4 to 27)		Main supply line from FACP or external source according to Fig. 34
2	0 V		
3	+10.5 to +30 VDC (UL/FM = 12.4 to 27)		Redundant supply line from FACP or external source according to Fig. 34
4	0 V		
5	+ Power supply		Wiring of feedback loop signals according to Fig. 41
6	Output fault, OC (all fault events)		
7	Output alarm I, OC		
8	Output alarm II or freely programmable, OC		
9	unused		
10	Rel. 1 ("NO") ①	Fault	Wiring the line according to Fig. 38 to Fig. 39 or specifications of the used line
11	Rel. 1 ("NC")		
12	Rel. 1 "COM" ①		
13	Rel. 2 "NO"	Alarm I	
14	Rel. 2 "NC"		
15	Rel. 2 "COM"		
16	Rel. 3 "NO"	Alarm II or freely programmable	
17	Rel. 3 "NC"		
18	Rel. 3 "COM"		
19	Reset external input + (opto-isolator input)		Wiring acc. to Fig. 35 and Fig. 37
20	Reset external input - (opto-isolator input)		
21	+ F	+ power supply "F"	(may be available at a later date)
22	WFS	Asynchronous data line "F"	
23	-	0 V power supply "F"	
24	+ S	+ power supply "S"	Connection MFU 535, REK 535 (available at a later date)
25	DS	Asynchronous data line "S"	
26	-	0 V power supply "S"	



Notice

- ① The "Fault" relay has picked up in the normal state → contact Te. 12/10 closed, 12/11 open (ASD 535 under voltage; no fault present).

AMB 35 internal connections

AMB terminal	Signal	Wiring
MOT / M-	Fan -	Fan, black wire
MOT / T	Fan tachometer signal	Fan, white wire
MOT / M+	Fan +	Fan, red wire
OEM2 / AI-	Opto-isolator inputs for OEM2	Wiring similar to Fig. 35 (see also Sec. 2.2.8)
OEM2 / AI+		
OEM2 / St-		
OEM2 / St+		
OEM1 / AI-	Opto-isolator inputs for OEM1	
OEM1 / AI+		
OEM1 / St-		
OEM1 / St+		



Warning

- In some cases, actuations may **not** comply with **EN 54-20**; thus, use only after consulting with the manufacturer).
- The inputs are **not** line monitored.

6.5.2 eXtended Line Module XLM 35 / SecuriLine module SLM 35 terminal assignment

SLM terminal	Signal	Wiring
L1 / T	Data A	Addressable loop acc. to Fig. 37 or Fig. 40 (see also Sec. 8.5.4)
C1 / U	GND A	
G1 / V	Screen	
L2 / X	Data B	Addressable loop acc. to Fig. 37 or Fig. 40 (see also Sec. 8.5.4)
C2 / Y	GND B	
G2 / Z	Screen	

6.5.3 Relay interface module RIM 35 terminal assignment

RIM terminal	Signal ①	Wiring	
1	Pre-signal 1 or freely programmable	Local info or wiring on FACP input	
2 Rel. 1			"NO"
3			"COM"
4	Pre-signal 2 or freely programmable		
5 Rel. 2			"NO"
6			"COM"
7	Pre-signal 3 or freely programmable		
8 Rel. 3			"NO"
9			"COM"
10	Dirty smoke sensor or freely programmable		
11 Rel. 4			"NO"
12			"COM"
13	Sampling tube pipe blockage or freely programmable		
14 Rel. 5			"NO"
15			"COM"

Notice



① Depending on the device version, the assigned criteria (signals) upon product delivery apply to smoke sensor I on the first RIM 35 (connected to the AMB 35) and to smoke sensor II on the second RIM 35 (connected to the first RIM 35, cascaded). The assignment of individual or all relays can be changed with the "ASD Config" configuration software.
If two RIM 35 devices are deployed in the ASD 535-1 or ASD 535-3, the relays of the second RIM 35 are not configured with default criteria. The required programming must be performed with the "ASD Config" configuration software.

6.5.4 Terminal assignment of an SIM 35 serial interface module

SIM terminal	Signal	Wiring / installation (see also Sec. 8.5.6)
1	GND	Input 1 st conductor from wire pair 2 1 st conductor from wire pair 1 2 nd conductor from wire pair 1 twisted
2	D +	
3	D -	
4	GND	Output 1 st conductor from wire pair 2 1 st conductor from wire pair 1 2 nd conductor from wire pair 1 twisted
5	D +	
6	D -	

6.6 Connection variants



Notice

The connection variants are determined by the possible lines and FACP technologies. For more information about wiring alarm transmitters, line monitoring elements etc., please contact the manufacturer and/or supplier of the fire detection system.

In all cases the ASD 535 must have an emergency power supply compliant with EN 54-4.

6.6.1 Power supply

The ASD 535 must always have emergency power supply. Depending on the available output current of the fire alarm control panel (FACP) and the number of ASD 535 units to be connected, the power supply can be provided by the FACP or the power supply will have to be supplied by auxiliary means locally.

The supply is via terminals 1 and 2. In applications where a redundant power supply line is prescribed (country specific), it is connected to terminals 3 and 4 (**Fig. 34**).



Notice

- The supply inputs are not connected internally in the ASD and thus cannot be used for direct continuation to neighbouring systems.
- The terminals of the ASD 535 are designed for maximum 2.5 mm². For continuing the supply line to a neighbouring ASD it may be necessary to install additional distributor or support terminals.

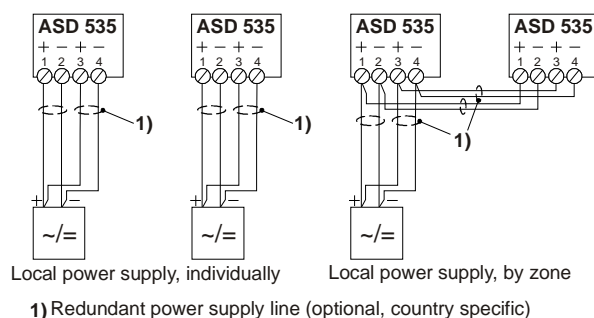
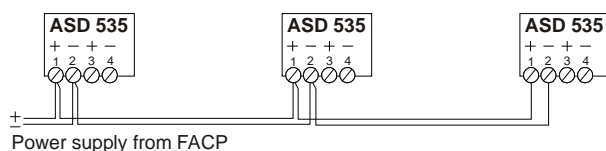

Fig. 34 Types of power supply



Danger

To determine the required power supply and cable cross-section, it is essential to perform the calculations described in Sec. 4.9.2. For applications with redundant power supply, the calculations must be performed for both supply lines individually.

6.6.2 Reset input

The reset input is potential-free (opto-isolator) and can be actuated "plus" side or "minus" side (**Fig. 35**). The input operates in the range of 5 to 30 VDC and in an impulse bandwidth of 0.5 to 10 s. Thanks to the continuous current consumption of approx. 3 mA in the overall operating range, the triggering can be performed directly via an open collector module.

If a continuous signal is present longer than 20 s, the ASD 535 is switched inactive, the fault relay becomes active (triggered), and the fan is switched off. Once the continuous signal is switched off, the ASD is switched to armed again. Switching inactive via the "Reset external" input works only if the ASD 535 is not equipped with an XLM 35 or SLM 35.

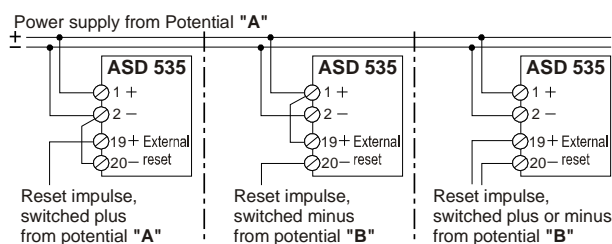

Fig. 35 Reset input

6.6.3 Control

The ASD 535 units connected to a FACP are controlled according to the detection zone mapping using the FACP states “Zone ON/OFF” and “Reset”. Two possibilities are available:

- Control via supply voltage (auxiliary relays in the ASD power supply line)
- Control via the “Reset external” input.

6.6.3.1 Control via supply voltage by means of auxiliary relay

Depending on the location of the ASD supply, the auxiliary relay may be placed in the FACP or directly in the ASD 535.

The auxiliary relay can be actuated in the following ways (see Fig. 36):

- line plus or minus
- SW output of the FACP
- SW output or function of a control module

The function types listed above are determined by the FACP technology in use. It is therefore essential to contact the manufacturer and/or the supplier of the fire alarm unit before implementing.



Danger

- The EMC protective elements at the input of the ASD electronics cause a brief current peak (5 A / 1 ms). When using auxiliary relays with a max. contact load of 1 A, this may lead to the relay contact sticking. For this reason auxiliary relays with a contact load of over **1 A** should **always** be used, e.g. PMR 81 semiconductor relay (see Fig. 36 C).
- The ASD supply path via the auxiliary relay contact must be short-circuit-proof or conducted via a fuse component (circuit-breaker card).



Notice

- When using a PMR 81 semiconductor, it may be necessary to invert the actuation signal (PMR has only a normally open contact function).
- To guarantee comprehensive emergency running properties, the wiring must in all cases be implemented in such a way that if there is an FACP computer failure the ASD will continue to function (reset input not actuated).

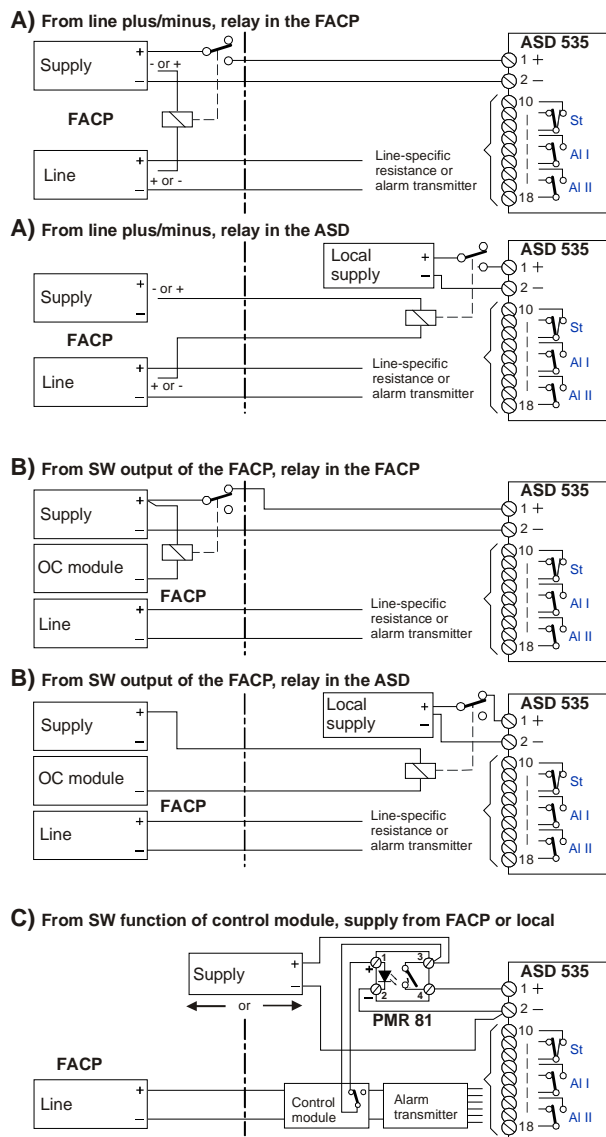

Fig. 36 Control via supply with relay

6.6.3.2 Control via the “Reset external” input

The following options are available for control via the reset input (see Fig. 37):

- A. Control via auxiliary relay from line plus
- B. Control via auxiliary relay or semi-conductor relay (PMR 81) from control output (open collector)
- C. Control without auxiliary relay, directly from control output (relay contact or open collector)
- D. Control via addressable loop when using the XLM 35 / SLM 35. The control is then not by means of the reset input but rather directly with the corresponding command entry via the XLM 35 / SLM 35 on the ASD 535.

The function types listed above are determined by the FACP technology in use. It is therefore essential to contact the manufacturer and/or the supplier of the fire alarm unit before implementing.

Notice

- When using a PMR 81 semiconductor, it may be necessary to invert the actuation signal (PMR has only a normally open contact function).
- To guarantee comprehensive emergency running properties, the wiring must in all cases be implemented in such a way that if there is an FACP computer failure the ASD will continue to function (reset input not actuated).

Warning

Attention: When control is via the “Reset external” input, the ASD 535 is supplied with voltage even if the zone (FACP) is switched off.

For this reason, if any repair work is performed on the device, the supply line to the ASD must be disconnected (e.g. pull off terminals 1 and 2 on the ASD; do the same for 3 and 4 for redundant supply).

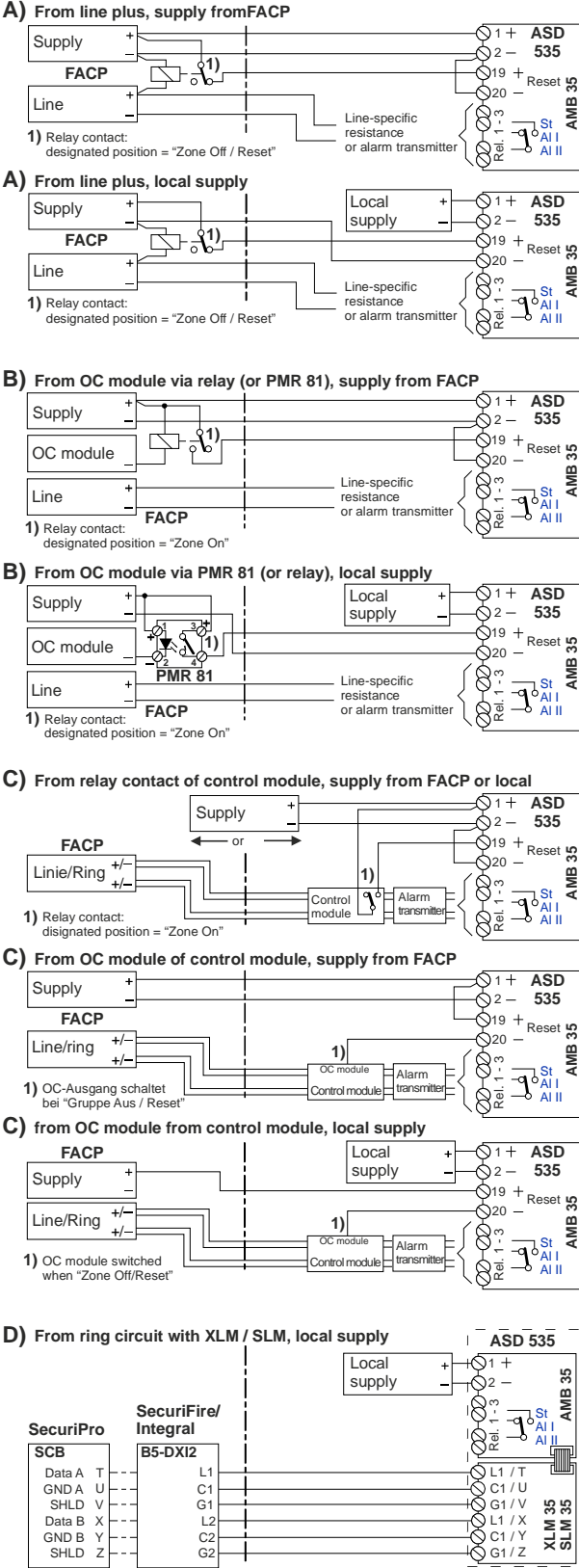

Fig. 37 Control via the “Reset external” input

6.6.4 Wiring the FACP line

The following examples show how control via reset input as described in Sec. 6.6.3.2 is implemented. If wiring with control via the voltage supply is necessary, the control circuit in the following figures can be implemented as described in Sec. 6.6.3.1.

6.6.4.1 Circuitry on zone detection via AI / St relay

- For circuitry on zone detection lines, actuation of the auxiliary relay is, as a rule, from the line plus. A condition for this, however, is that the line plus also switches for “Zone ON/OFF” and “Reset” (see Fig. 38, C) for exception).
- Circuitry as shown in Fig. 38, B) is used exclusively when the FACP line is to operate with **2-detector dependency (V-AI / H-AI)** from smoke sensors I and II. For that purpose the FACP line is programmed for 2-detector dependency. The ASD has **two** sampling pipes which cover the **same monitoring area**, or only **one**, and **merging** takes place before the ASD on tube input I and II (see Sec. 4.6).
- When wiring as shown in Fig. 38, C), AI I and AI II can be evaluated in the FACP as independent zones from two independent monitoring areas. A **2-line dependency** can also be programmed in the FACP. In that case, the same applies as in B); both sampling pipes from one monitoring area, or merging of a sampling pipe on tube input I and II according to Sec. 4.6.

- If wiring as in Fig. 38, C) is used, the control signal for the reset input can no longer be picked up from the line plus; instead, a software output has to be created with the following programming:

Output switches when:

Line/Zone A or B “Reset”

or:

Line/Zone A and B “Off”

A) ASD 535 with one smoke sensor, connected to one line

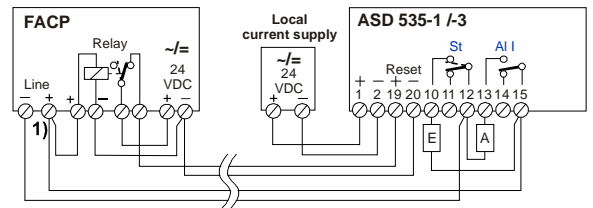
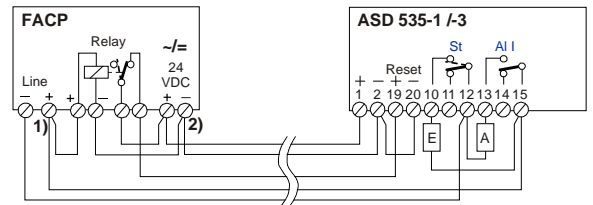

B) ASD 535 with two smoke sensors, connected to one line

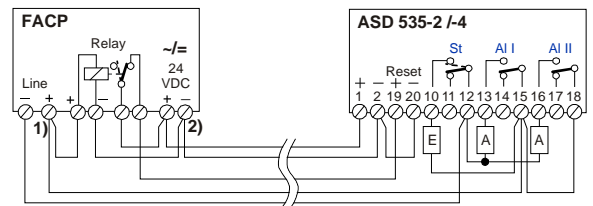

When using local current supply: see "A")

C) ASD 535 with two smoke sensors, connected to two lines

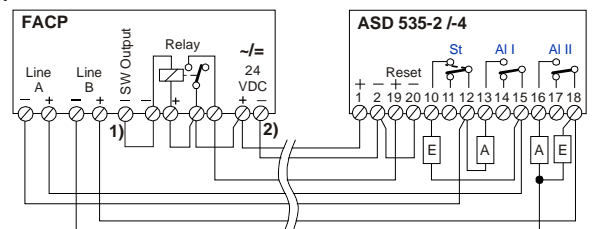

When using local current supply: see "A")

- 1) Output switches if: "Line/zone A or B reset"
or: "Line/zone A and B Off"
- 2) From short-circuit card if not short-circuit proof

E = terminal resistor (only in the last ASD)
A = alarm resistor

Fig. 38 Wiring for zone detection

6.6.4.2 Circuitry on selective identification or addressable loop via AI / St relay

- For line technologies such as selective identification lines and addressable loops, actuation of the auxiliary relay is to be implemented from a software-controlled output (output card or control module). The output is programmed via the FACP software with the “Zone Off” and “Reset” functions.
- If **AI I** and **AI II** are evaluated in the FACP as individual zones (also 2-line dependency), programming of the SW output is as follows:

Output switches when:

Zone A or B “Reset”

or:

Zone A and B “Off”

A normal relay or a PMR 81 semi-conductor relay can be used as control relay.

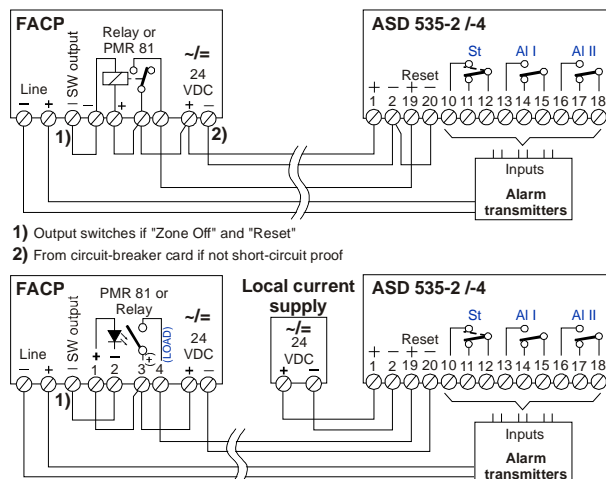

Fig. 39 Wiring for selective identification or addressable loop

6.6.4.3 Circuitry on SecuriPro / SecuriFire / Integral addressable loop from XLM 35 / SLM 35

- For the circuitry on SecuriPro / SecuriFire / **Integral** addressable loop from the XLM 35 / SLM 35 no additional control relay is needed. Likewise, the **AI** and **St** relays of the ASD 535 are not used. The state query and the control of the ASD 535 take place directly between the XLM 35 or SLM 35 and the addressable loop.
- When using an ASD 535 with two smoke sensors and XLM 35 / SLM 35 (ASD 535-2 or ASD 535-4), a 2-detector dependency (**V-AI / H-AI**) can be programmed on the FACP. Evaluation of the individual zones (**AI I** and **AI II**) in the FACP is also possible.
- On the **SLM 35** the S2 switch is positioned at “I” or “I + II”, depending on the ASD type (number of smoke sensors).

Maximum connectable XLM 35 / SLM 35 units:

(see also notice box below)

per SecuriLine (only SLM 35)	50 units
per SecuriFire / Integral addressable loop	32 units

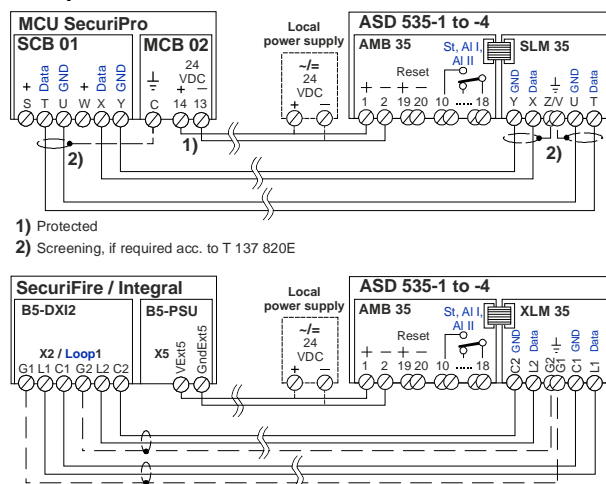

Fig. 40 Wiring from XLM 35 / SLM 35



Notice

- There are two switches – S1 and S2 – on the **SLM 35** that have to be differently set depending on the use of the ASD 535. Please see Sec. 8.5.4.
- When operating an ASD 535-2 and ASD 535-4 (with 2 smoke sensors), two addresses are allocated on the **SLM 35**.
- The circuitry and wiring routing between **SLM 35** and the FACP SecuriPro, SecuriFire or **Integral** must be carried out as shown in **Fig. 40** (X on X, Y on Y or X on L2, Y on C2, etc.).
- The installation of the SecuriFire / Integral addressable loop must be shielded.
- The circuitry and wiring routing between **XLM 35** and the FACP SecuriFire or **Integral** must be carried out as shown in **Fig. 40** (L1 on L1, C1 on C1, etc.).

6.6.5 Open collector outputs

The ASD criteria “Alarm I”, “Alarm II” and “Fault” (all fault events) are available as open collector outputs.

Parallel and feedback indicators and other consumers (e.g. relays) can be connected to the open collector outputs.

In ASD 535-1 and ASD 535-3 the output on terminal 8 is not “Alarm II” but rather freely programmable (it is always identical with the programming on relay 3 of the AMB 35).

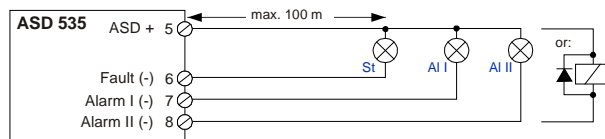

Fig. 41 Wiring the OC outputs



Danger

When connecting inductive consumers (e.g. relays), a freewheel diode is to be installed directly at the consumer (Fig. 41).



Notice

The outputs are 0-Volt switched and have a loading capacity of max. **100 mA** per output. All outputs together cannot switch more than **200 mA**. The electrical strength is 30 VDC per output. The outputs are not short-circuit-proof and not potential-free. Connection to the outputs affects the overall power consumption of the ASD 535.

7 Commissioning

7.1 General information



Warning

The following points must be observed when commissioning the ASD 535 aspirating smoke detector:

- Commissioning the ASD 535 may be performed only by trained and qualified personnel.
- Prior to commissioning, it must be ensured that the entire sampling pipe has been correctly mounted (junctions, sampling holes).
- If there is a maintenance sampling hole as described in Sec. 4.4.4.6, it must be closed with adhesive tape or the maintenance clip.
- Prior to commissioning, an inspection of the mounting and installation must ensure that when the power supply is switched on there can be no damage to the ASD 535.
- Rewiring the device may be performed only when voltage is disconnected. Exception: logging off expansion modules XLM, SLM, RIM, MCM, SIM (see Sec. 7.3.7).
- Before switching on, the smoke sensors and any expansion modules in the detector housing must be fitted and connected to the AMB 35 **Main Board** by means of the supplied flat cable. See also Sec. 6.3 and 6.4.
- Before switching on the ASD power supply, ensure that all fire incident controls and remote alerting are blocked from the ASD 535 or deactivated.
- Directly before switching on the ASD 535 the first time, remove the isolation strips from the **Lithium** battery (AMB 35).
- The performance of this system is dependent upon the sampling pipe. Any extensions or modifications to the designed installation may cause improper operation. The operational effects of such changes shall be verified. Section 4 (planning) must be considered in any case. The Calculation software “ASD PipeFlow” is available from the manufacturer.

The detector housing has to be opened for commissioning the ASD 535 (see Sec. 5.4.1). To prevent the housing cover from hanging loosely on the flat cable connection to the AMB 35, it is fastened with the top rotary quick-release locks to the middle mounting points (**Fig. 42**).

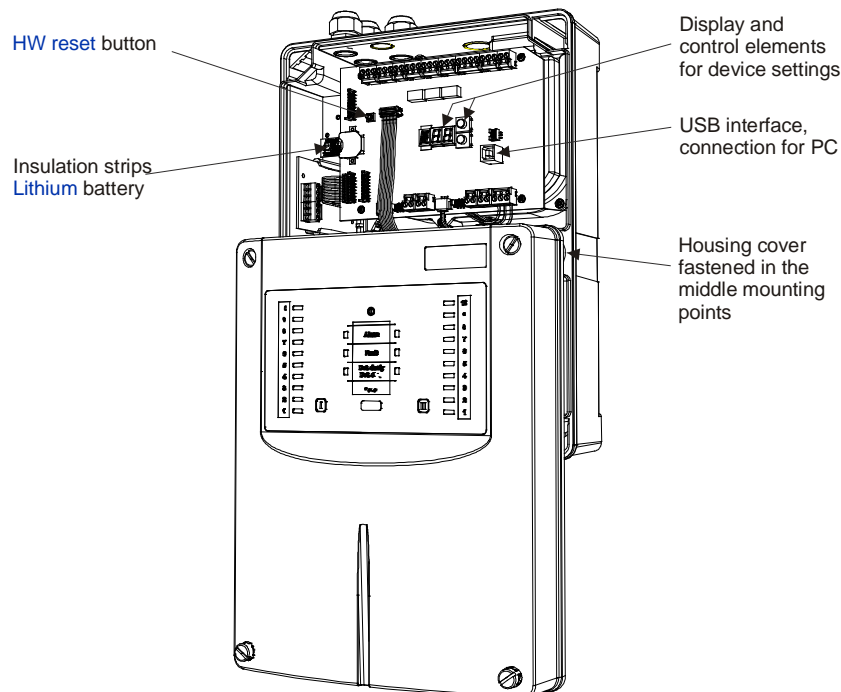

Fig. 42 Opened detector housing for commissioning

7.2 Programming

The ASD 535 has several switch settings which are configured with permanently assigned parameters:

- Normative system limits according to EN 54-20, Class A to C, switch settings **A11** to **C32**
- Non-normative system limits, switch settings **W01** to **W48**
- Configurable switch settings for saving settings after using “ASD PipeFlow” and/or changing the device configuration via the “ASD Config” configuration software and SecuriPro, SecuriFire or Integral FACP (XLM 35 or SLM 35), **X01** to **X03**.

A detailed description of all switch settings is in Sec. 8.3.

If the ASD 535 is operated with **EasyConfig**, i.e. within the present system limits according to the tables in Sec. 4.4.4.3 and 4.4.4.4, then only switch settings **A11** to **C32** and **W01** to **W48** are to be selected; it is not necessary to use the “ASD Config” configuration software.

In systems where the sampling pipe planning was performed with the “ASD PipeFlow” calculation software, the response sensitivities of the smoke sensors calculated by “ASD PipeFlow” have to be programmed on the ASD 535 with “ASD Config”. Saving in the ASD 535 is done on one of the freely programmable switch settings **X01** to **X03**. Subsequent ASD 535 operation is on the respective switch settings **X01** to **X03**.

Switch settings **X01** to **X03** are configured with default values when the device is delivered. These are:

- Setting **X01** of setting **A11** (for ASD 535-2 /-4 = **A12**)
- Setting **X02** of setting **b11** (for ASD 535-2 /-4 = **b12**)
- Setting **X03** of setting **C11** (for ASD 535-2 /-4 = **C12**)

The following parameters can be changed using the “ASD Config” configuration software (see Sec. 7.2.1):

- Alarm thresholds of the smoke sensors
- Trigger thresholds for dust and dirt (individually)
- Trigger thresholds for pre-signals 1, 2 and 3 (individually, for each smoke sensor)
- Delay times for dust and dirt, pre-signals, alarms and faults (individually)
- Sensitivity and delay time of the airflow monitoring
- Deactivation of self-hold for dust and dirt, pre-signals, alarms and faults (individually)
- Deactivation of criteria (pre-signals, dust/dirt, faults)
- Fan speed
- Date / Time
- Autolearning (On/Off, duration)
- Day/night operation
- Relay allocation (AMB 35 relay 3, RIM 35)
- Open collector output 3 (always like AMB 35 relay 3)



Warning

The parameters are configured ex factory with default states and values so that the triggering properties comply with EN 54-20. Changing the parameters may result in non-compliance with EN 54-20. Any adjustments or modifications to the ASD 535 via “ASD Config” may be performed only by the manufacturer or by persons under the supervision of and trained by the manufacturer.

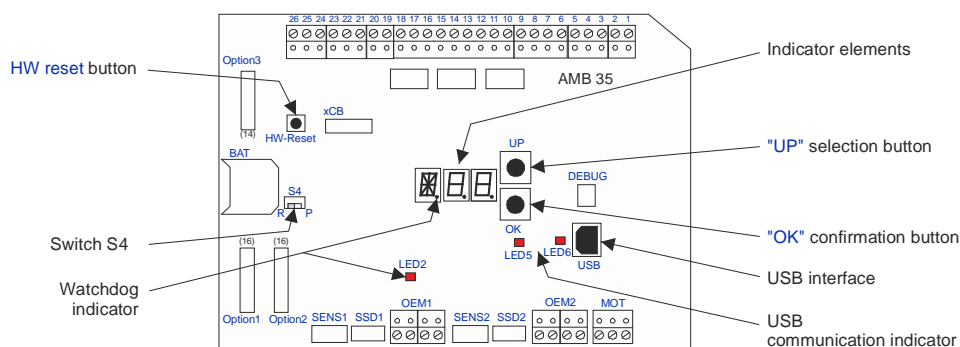

Fig. 43 Control and indicator elements on the AMB 35

7.2.1 Configuration options

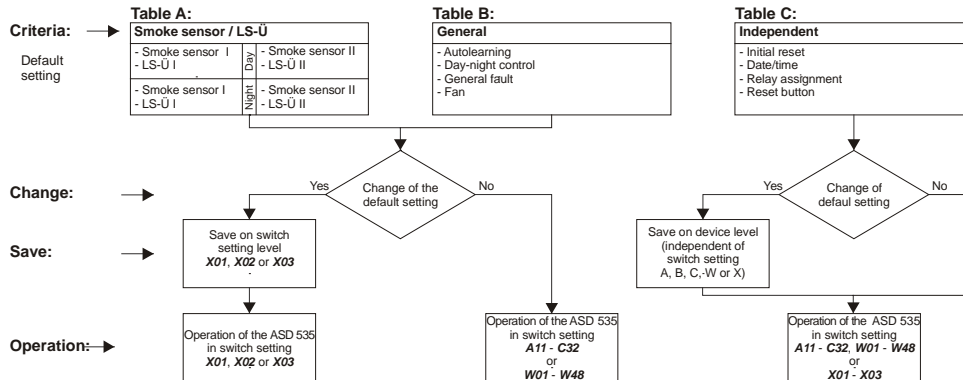

Fig. 44 Configuration overview

Table A: The following criteria can be set for each smoke sensor / sampling pipe. Also, the criteria for day/night control can be separately set. Configuration changes are saved on one of the freely programmable switch settings **X01** to **X03**.

Sector	Default adjustment	Range	Resolution / levels	Saving after change
• Parameter				
Alarm 2				
• Alarm 2 On / Off	Off	Off / On		X01 – X03
• Sensitivity (always at least 20% over Alarm)	1 %/m	– 10 %/m	0.0002 %/m	X01 – X03
• Alarm 2 delay	2 s	0 s – 60 s	1 s	X01 – X03
• Alarm 2 self-hold	On	On / Off		X01 – X03
• Holding time for area switching (AI 2 to AI)	20	10 – 250	1 s	X01 – X03
Alarm (EN 54-20)				
• Alarm threshold (dependent on smoke sensor type and response class according to EN 54-20)	C11 / C12	0.02 – 10%/m 0.1 – 10%/m 0.5 – 10%/m	0.0002%/m	X01 – X03
• Smoke level average value formation (number)	4	1 – 10	1	X01 – X03
• Alarm delay (UL/ULC max. 30 s)	2 s	0 s – 60 s	1 s	X01 – X03
• Alarm cascade	Off	Off / On		X01 – X03
• Alarm self-hold	On	On / Off		X01 – X03
Pre-signal				
• Pre-signal 1 On / Off	On	On / Off		X01 – X03
• Pre-signal 2 On / Off	On	On / Off		X01 – X03
• Pre-signal 3 On / Off	On	On / Off		X01 – X03
• Pre-signal 1 (100% = alarm threshold)	30%	10 – 90%	10%	X01 – X03
• Pre-signal 2 (100% = alarm threshold)	50%	VS 1 + 10 – 90%	10%	X01 – X03
• Pre-signal 3 (100% = alarm threshold)	70%	VS 2 + 10 – 90%	10%	X01 – X03
• Pre-signal delay (VS 1 – VS 3)	2 s	0 s – 60 s	1 s	X01 – X03
• Pre-signal self-hold	Off	Off / On		X01 – X03
Smoke sensor dust/dirt				
• Smoke sensor dust On / Off	On	On / Off		X01 – X03
• Smoke sensor dirt On / Off	On	On / Off		X01 – X03
• Dust threshold (% of AI)	50%	5 – 60%	5%	X01 – X03
• Dirt threshold (% of AI)	75%	65 – 90%	5%	X01 – X03
• Dust self-hold	On	On / Off		X01 – X03
• Dirt self-hold	On	On / Off		X01 – X03
• Fault delay of smoke sensor	30 s	0 s – 60 s	1 s	X01 – X03
Airflow monitoring				
• LS-Ü pipe blockage On / Off	On	On / Off		X01 – X03
• LS-Ü pipe breakage On / Off	On	On / Off		X01 – X03
• LS-Ü sensitivity (applies to A01 to C32) ①	±20% ①	±10 – ±70%	± 10%	X01 – X03
• LS-Ü average value formation (number)	20	1 – 30	1	X01 – X03
• LS-Ü delay time (applies to A01 to C32) ①	300 s ①	2 min – 60 min	10 s / 1 min	X01 – X03



Notice

① Increased values are configured for **W01** to **W48**; the values are not tested in accordance with EN (see Sec. 4.4.4.4).

Table B: The following criteria apply to the entire ASD 535. Saving a configuration after changes is performed in the context of the adaptations in Table A on one of the freely programmable switch settings **X01** to **X03**.

Sector • Parameter	Default adjustment	Range	Resolution / levels	Saving after change
Autolearning				
• Autolearning On / Off	Off	On		X01 – X03
• Autolearning duration	3 days	1 min to 14 days	min, h, days	X01 – X03
• Autolearning factor (of measured AI threshold)	1.5	1.1 – 10 x		X01 – X03
Day/night control / day of the week control				
• Day/night control On / Off	Off	Off / Clock / FACP		X01 – X03
• Day start time	06:00	00:00 – 24:00	15 min	X01 – X03
• Night start time	20:00	00:00 – 24:00	15 min	X01 – X03
• Day of the week control	On	Mo to Su	days	X01 – X03
General faults				
• Lithium battery / clock fault	On	On / Off		X01 – X03
Fan				
• Fan speed	Level III	Level I to V	1	X01 – X03
Deactivate / switch off sensor				
• Smoke sensor I / Smoke sensor II • Switch off (partial planning) only smoke sensor II	On	On / deactivated / switched off (partial planning)		X01 – X03

Table C: Independent configurations. These can be changed independently of the switch settings in the ASD 535.

Sector • Parameter	Default adjustment	Selection
Time		
• Year, month, day, hour, minute	---	Minutes – year
Relay / OC output / reset button / various		
• Relay 3 and OC output 3, AMB 35	Alarm II	According to Sec. 7.2.2
• Relay 1, 1st RIM 35	Pre-signal 1 smoke sensor I	According to Sec. 7.2.2
• Relay 2, 1st RIM 35	Pre-signal 2 smoke sensor I	According to Sec. 7.2.2
• Relay 3, 1st RIM 35	Pre-signal 3 smoke sensor I	According to Sec. 7.2.2
• Relay 4, 1st RIM 35	Smoke sensor I dirty	According to Sec. 7.2.2
• Relay 5, 1st RIM 35	Sampling tube I pipe blockage	According to Sec. 7.2.2
• Relay 1, 2nd RIM 35	Pre-signal 1 smoke sensor II	According to Sec. 7.2.2
• Relay 2, 2nd RIM 35	Pre-signal 2 smoke sensor II	According to Sec. 7.2.2
• Relay 3, 2nd RIM 35	Pre-signal 3 smoke sensor II	According to Sec. 7.2.2
• Relay 4, 2nd RIM 35	Smoke sensor II dirty	According to Sec. 7.2.2
• Relay 5, 2nd RIM 35	Sampling tube II pipe blockage	According to Sec. 7.2.2
• Reset button On / Off	On	On / Off
• Heating control, subsequent heating time	2 min	1 – 60 min
• MCM settings, recording interval	1 s	1 – 120 s
• MCM smoke peak value memory	Off	Off / On
• Perform initial reset	---	On / Off
• Smoke sensor operation mode (smoke sensor I / II)	SSD/DMB	SSD/DMB or OEM inputs (single or in combination) Switched off
• Isolate smoke sensor (smoke sensor I / II)	Normal operation	Isolate / normal operation

7.2.2 Relay allocation

The following criteria can be programmed on a max. of 11 relays (1 AMB 35 unit on ASD 535-1 and ASD 535-3, 5 units on 1st RIM 35, 5 units on 2nd RIM 35):

Smoke sensor I / LS-Ü I	Smoke sensor II / LS-Ü II	General
Smoke sensor I alarm	Smoke sensor II alarm	Fan fault
Pre-signal 1 smoke sensor I	Pre-signal 1 smoke sensor II	Operating voltage fault
Pre-signal 2 smoke sensor I	Pre-signal 2 smoke sensor II	Initial reset fault
Pre-signal 3 smoke sensor I	Pre-signal 3 smoke sensor II	Lithium battery / clock fault
Smoke sensor I dusty	Smoke sensor II dusty	
Smoke sensor I dirty	Smoke sensor II dirty	
Smoke sensor I fault	Smoke sensor II fault	
Sampling tube I pipe blockage	Sampling tube II pipe blockage	
Sampling tube I pipe breakage	Sampling tube II pipe breakage	
Heating control sampling pipe I	Heating control sampling pipe II	
Alarm 2 sampling pipe I	Alarm 2 sampling pipe II	

The criteria can also be allocated with the or function (example: smoke sensor dust or dirt together on one relay).

7.3 Starting up

The necessary information about control and indicator elements for starting up can be seen in **Fig. 43**.

Warning

Before the ASD 535 is switched on, all of the required precautions as described in Sec. 7.1 must have been carried out.

7.3.1 Commissioning using EasyConfig

The workflow for commissioning with **EasyConfig** is shown below (planning without “ASD PipeFlow” calculation, without the “ASD Config” configuration software). When RIM 35 expansion modules are built in, the RIM relays react according to the details in Sec. 2.2.6 and 7.2.1, table C. The default values are also in effect for all other settings as described in Sec. 7.2.1.

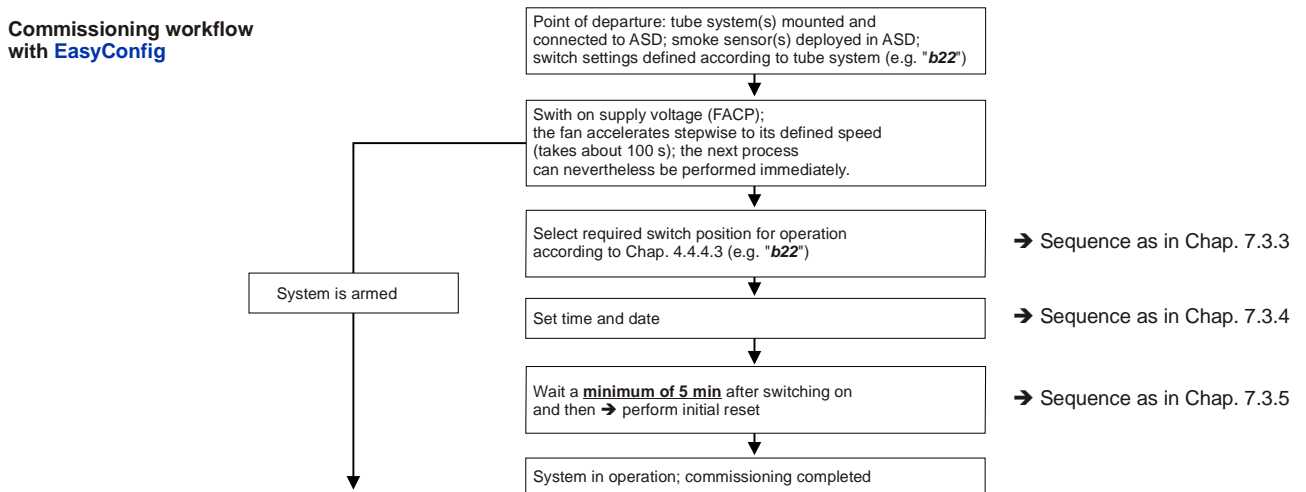

Fig. 45 Commissioning workflow using EasyConfig

7.3.2 “ASD Config” configuration software

The workflow for commissioning with the “ASD Config” configuration software is shown below. The “ASD Config” configuration software is required only if changes have to be made to the default configuration profile (Sec. 7.2.1) or after using the “ASD PipeFlow” calculation software.

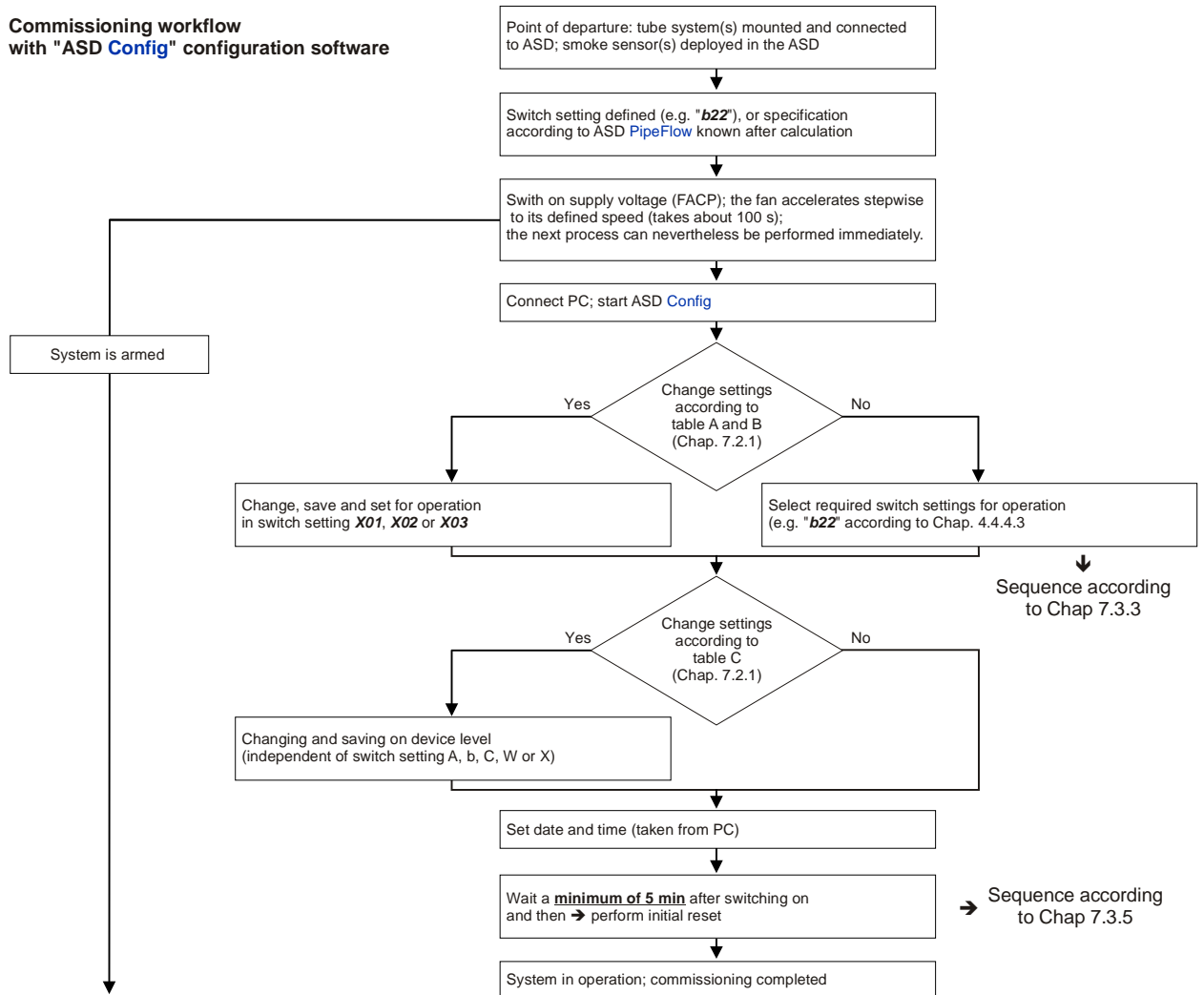



Fig. 46 Commissioning workflow with “ASD Config” configuration software

7.3.3 Settings on pre-defined switch settings A11 to C32, W01 to W48







The following describes the procedure when the ASD 535 has to be set on one of the fixed parameterized switch settings **A11** to **C32** or **W01** to **W48**.

Example: ASD 535-4 (with 2 sampling pipes) should respond in compliance with EN 54-20, Class B. The sampling pipes are U-shaped, within system limit 2. As specified in Sec. 4.4.4.3, switch setting **b22** must be selected.



Warning

















Switch settings **W01** to **W48** may be used only after consulting with the manufacturer. The configured values they contain concerning airflow monitoring are **not** tested in accordance with EN.

Measure	Display/indication	Procedure/comment
(1)  Press key	flashing C32	<ul style="list-style-type: none"> Displays the default setting
(2)  Press the key again until the display is on b	in succession A / b	<ul style="list-style-type: none"> Displays the switch position group b
(3)  Press key	b11	<ul style="list-style-type: none"> Displays the smallest possible switch position in group b
(4)  Press the key until the display is on b21	alternating b11 / b12 / b21 / b22	<ul style="list-style-type: none"> Displays the possible switch positions in group b
(5)  Press key	flashing b - - (approx. 4 x)	<ul style="list-style-type: none"> New setting is programmed
(6)  Press the key to check the change	flashing b22	<ul style="list-style-type: none"> Displays the new setting

7.3.4 Setting date and time

The following sequence shows how to set the time and date.

Example: Setting to 10 June 2010; 11:05:00

Measure	Display/indication	Procedure/comment
(1)  Press key	flashing C32 or other	<ul style="list-style-type: none"> Displays the default setting or the installation-specific switch position as described in Sec. 4.4.4.3
(2)  Press the key again until the display is on T	in succession A / b / C / E / F / I / o / T	<ul style="list-style-type: none"> Displays the switch position group T
(3)  Press key	RE ①	<ul style="list-style-type: none"> Date/time display, polling mode ①
(4)  Press the key until the display is on SE	in succession RE / SE	<ul style="list-style-type: none"> Date/time display, input mode
(5)  Press key > Year	Y10	<ul style="list-style-type: none"> Displays the year 2010
(6)  Press the key until Y13	Y13	<ul style="list-style-type: none"> Selected year 2013
(7)  Press key > Month	M01	<ul style="list-style-type: none"> Displays the month of January
(8)  Press the key until M06	M06	<ul style="list-style-type: none"> Selected month June
(9)  Press key > Day	d01	<ul style="list-style-type: none"> Displays the first day of the month
(10)  Press the key until d10	d10	<ul style="list-style-type: none"> Selected day is 10
(11)  Press key > Hour	H00	<ul style="list-style-type: none"> Displays hour 00
(12)  Press the key until H11	H11	<ul style="list-style-type: none"> Selected hour is 11
(13)  Press key > Minute	M00	<ul style="list-style-type: none"> Displays minute 00
(14)  Press the key until M05	M05	<ul style="list-style-type: none"> Selected minute is 05
(15)  Press key > Second	S00	<ul style="list-style-type: none"> Displays second 00
(16)  Press the key until S30	S30	<ul style="list-style-type: none"> Selected second is 30
(17)  Press the key, date and time are programmed	Flashing T - - (approx. 4 x)	<ul style="list-style-type: none"> The date is set to 10.06.2013, and the clock starts to run from the time 11:05:30



Notice

① **Poll date and time:**
In the **T > RE** switch position, pressing “OK” outputs the currently set date and the current time on the ASD 535.
Example: In sequence **Y13 > M06 > d10 > H11 > M05 > S57**.





7.3.5 Initial reset

When commissioning the ASD 535, an initial reset is required. When this happens, the airflow monitoring is automatically aligned to the connected sampling pipe.





Notice

- The initial reset must always be performed under the installation's "normal conditions", i.e. ventilation systems, air conditioning systems etc. must be running in "normal operation".
- If a maintenance sampling hole is present, it must be closed with adhesive tape or with the maintenance clip.
- The initial reset must be performed with normal ventilation for equipment monitoring of ventilated objects.
- If there is an expansion, conversion, retrofitting or repair on the sampling pipe, an initial reset is imperative.
- An initial reset must be performed after the fan speed has been changed.
- After an FW upgrade, an initial reset is required only if it is expressly mentioned in the concerned firmware description.
- Before performing an initial reset (i.e. after switching on the ASD 535), it is imperative to observe a **waiting time of at least 5 min.**

Measure	Display/indication	Procedure/comment
(1)  Press key	flashing C32 or other	<ul style="list-style-type: none"> Displays the default setting or the installation-specific switch position as described in Sec. 4.4.4.3
(2)  Press the key again until the display is on U	in succession A / b / C / E / F / I / o / T / U	<ul style="list-style-type: none"> Displays the switch position group U
(3)  Press key	U01	<ul style="list-style-type: none"> Displays initial reset On
(4)  Press the key again	flashing U - - (5 to max. 120 s)	<ul style="list-style-type: none"> Initial reset in progress
(5) Wait	flashing point (watchdog indicator)	<ul style="list-style-type: none"> Initial reset completed

7.3.6 Display of firmware version

The currently loaded firmware version can be read out on the ASD 535 with the switch setting **F**.

Measure	Display/indication	Procedure/comment
(1)  Press key	flashing C32 or other	<ul style="list-style-type: none"> Displays the default setting or the installation-specific switch position as described in Sec. 4.4.4.3
(2)  Press the key again until the display is on F	in succession A / b / C / E / F	<ul style="list-style-type: none"> Displays the switch position group F
(3)  Press key	flashing after approx. 2 s, e.g. F01 . Pause F07 . Pause F00	<ul style="list-style-type: none"> Displays the firmware version, in this case 01.07.00





7.3.7 Logging off expansion modules XLM 35, SLM 35, RIM 35, MCM 35, SIM 35

The expansion modules (XLM 35, SLM 35, RIM 35, MCM 35, SIM 35) are automatically detected when the device is switched on, from which point they are monitored and functional. The MCM 35 begins logging data as soon as the SD memory card is inserted (indicated by the flashing red LED on the MCM). To read out the SD memory card or when subsequently removing an expansion module (e.g. if not used), the expansion module must first be logged off via operation on the AMB 35 Main Board.

Notice



A timeout (approx. 15 s) is configured for the logoff procedure. During this time the expansion modules can be electrically disconnected from the AMB 35 trouble-free or the SD memory card can be removed from the MCM. If during this time there is no removal (including removal of the SD memory card), the expansion modules are re-activated and logging on the MCM is continued.

Measure	Display/indication	Procedure/comment
(1)  Press key	flashing C32 or other	<ul style="list-style-type: none"> Displays the default setting or the installation-specific switch position as described in Sec. 4.4.4.3.
(2)  Press the key again until the display is on o	in succession A / b / C / E / F / I / o	<ul style="list-style-type: none"> Displays the switch position group o
(3)  Press key	o00	<ul style="list-style-type: none"> Displays logoff additional module
(4)  Press the key again	flashing o - - (timeout approx. 15 s)	<ul style="list-style-type: none"> Start logoff procedure, duration approx. 15 s
(5) Electrically disconnect (ribbon cable) the relevant additional module from the AMB 33 within the logoff time (15 s) or remove the SD memory card from the MCM.		<ul style="list-style-type: none"> If the module is not electrically disconnected from the AMB 33 within 15 s (including removal of the SD memory card), it is re-activated and data logging on the MCM continues.

7.4 Re-programming

Warning



The parameters are configured ex factory with default states and values so that the triggering properties comply with EN 54-20. Changing the parameters may result in non-compliance with EN 54-20. Any adaptations or changes to the ASD 535 via the “ASD Config” configuration software or by means of the user interface of the FACP may be performed only by the manufacturer or by qualified persons trained by the manufacturer.

7.4.1 Re-programming on the ASD 535

If a different switch setting has to be selected within the preset system limits (**A11** to **C32** or **W01** to **W48**), re-programming is performed as described in Sec. 7.3.3.

7.4.2 Re-programming with the “ASD Config” configuration software

When changing parameters as described in Sec. 7.2.1 and 7.2.2, the “ASD Config” configuration software must be used.

7.4.3 Re-programming from SecuriPro / SecuriFire / Integral with SLM 35

When connecting via an SLM 35 to the SecuriPro or [Integral](#) FACP, a limited re-programming of the ASD 535 from the user interface of the FACP is possible.



Notice

- When connecting from the SecuriPro, SecuriFire or [Integral](#) FACP, commissioning must always take place on the ASD 535. An initial reset from the FACP is not possible.
- Reprogramming from SecuriPro, SecuriFire or the [Integral](#) FACP is possible only if the slide switch on the SLM 35 is in the “**BMZ**” position. If the switch is in position “**ASD**”, the ASD is the master and from the FACP only a status query is possible (see also Sec. 8.5.5.1).
- Re-programming from the SecuriPro, SecuriFire or [Integral](#) FACP can be effected only in switch settings **X01** to **X03**.

The following criteria can be changed (pay attention to switch setting on SLM 35):

Criteria	Level	Corresponds to value in the ASD or (Ⓢ) range from FACP
Response sensitivity of the smoke sensors	High	80% of “medium”
	Medium	Corresponds to sensitivity based on A11 to W48 or “ASD PipeFlow” (= 100%)
	Low ②	120% of “medium”
Sensitivity of the airflow monitoring	High	±10% (Ⓢ ±10%)
	Medium	±20%, based on A11 to C32
	Low ②	±50% (Ⓢ ±30 – ±70%)
Delay time of the airflow monitoring	High ②	20 min (Ⓢ 11 – 60 min)
	Medium ②	10 min (Ⓢ 6 – 10 min)
	Low	300s, based on A11 to C32 (Ⓢ 10 – 300 s)
Restoration of the factory settings	Default	Above criteria on default values

= normative settings according to EN 54-20



Notice

A subsequent re-programming on the ASD is possible.

① The sensitivity levels on the user interface of the FACP comprise a default value and a defined range as regards the ASD configuration.

Example: after the ASD 535 is commissioned, the sensitivity of the airflow monitoring is set automatically to ±20% (default value, EN 54-20 compliant). If there is a subsequent re-programming from the FACP to level “low”, the ASD changes its configuration to ±50%. If further re-programming on the ASD using the “ASD Config” configuration software takes place (e.g. to ±30%), the “low” level is retained if the state is queried on the fire alarm control panel (for the FACP ±30% is in the same range as ±50%). In contrast, a change on the ASD to ±10% produces the display “high” on the FACP.



Warning

② Re-programming from the SecuriPro, SecuriFire or [Integral](#) FACP may result in non-compliance with EN 54-20. Any adaptations or modifications to the ASD 535 from the SecuriPro, SecuriFire or [Integral](#) FACP to level “low” may be performed only by the manufacturer or by qualified persons trained by the manufacturer.

7.4.4 Re-programming from SecuriFire / Integral with XLM 35

(In preparation) When the connection is via an XLM 35 to the SecuriFire or [Integral](#) FACP, controls and ASD device configuration changes can be performed directly from the FACP. Also, by means of the FACP operating software “SecuriFire Studio” or “[Integral Application Center](#)”, the “ASD Config” configuration software is launched for accessing the ASDs, enabling changes to the ASD 535.

7.5 Loading new firmware to the ASD 535

The firmware is located on the **Flash** PROM in the ASD 535. A FW upgrade is performed via the USB interface of the AMB 35 using the “ASD Config” configuration software. Selecting FW upgrade in “ASD Config” calls up the “Flasher Tool” program. To upgrade the FW, the **S4** switch on the AMB 35 in the ASD 535 is switched to position “**P**” and the “HW reset” button is actuated (see **Fig. 43**).

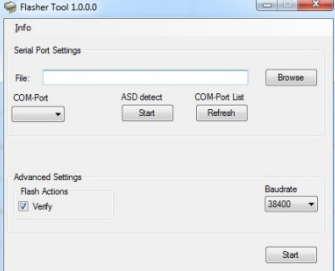
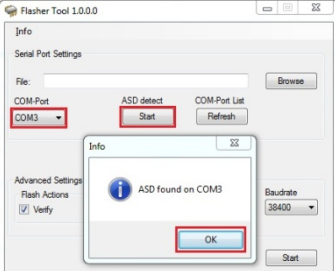
Notice		
	Actuating the “HW reset” in the S4 “P” switch position results in triggering the fault relay. When upgrading the firmware on the ASD 535, it is therefore essential to switch off fire incident controls and remote alerting on superordinate systems (FACP) beforehand.	
Measure	Display/indication	Procedure/comment
(1) Put the S4 switch on the AMB 35 in position “P”.		<ul style="list-style-type: none"> Prepare ASD for FW upgrade; ASD switches to Program-Mode.
(2) On AMB 35, briefly press the “HW reset” button.	LED 2 on AMB 35 is continuously lit	<ul style="list-style-type: none"> Indicator “Watchdog waits” ASD triggers fault Fan stops The segment display on the AMB 35 has an arbitrary state without meaning
(3) Select “Download Firmware” in “ASD Config”.		<ul style="list-style-type: none"> The “Flasher Tool” window opens with the basic settings.
(4) Select the “ASD detect” command (“Start”): <ul style="list-style-type: none"> Under “COM-Port” the USB Serial Port is automatically set to the connected ASD, Confirm the info message with “OK”. 		<ul style="list-style-type: none"> Display of required communication settings.

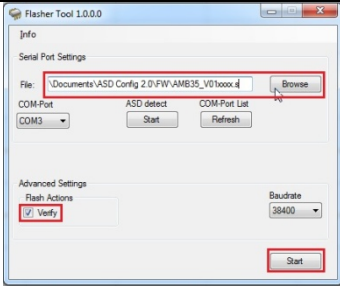
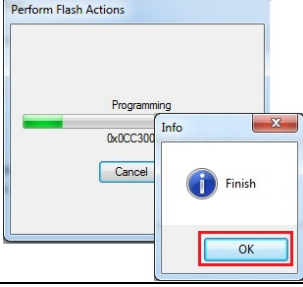

Continuation:

Measure	Display/indication	Procedure/comment
<p>(5)</p> <ul style="list-style-type: none"> • “Browse” to find the folder where the new operating FW is located • Select the file of the new FW and click “Open” • Leave the tick mark at “Verify” (default); • Actuate the “Start” button 		<ul style="list-style-type: none"> • Selection of the new FW.
<p>(6)</p> <p>Transmission to the ASD 535 begins. After completion, the info message “Finish” appears; confirm with “OK”.</p>		<ul style="list-style-type: none"> • Transmission duration approx. 150 s • During the transmission, LEDs 5 and 6 flash on the AMB 35
<p>(7)</p> <p>Put the S4 switch on the AMB 35 in position “R”.</p>		<ul style="list-style-type: none"> • ASD is again in Run-Mode
<p>(8)</p> <p>On AMB 35, briefly press the “HW reset” button.</p>	<p>LED 2 on AMB 35 goes out; the segment display flashes the previously set switch setting approx. 4 times (e.g. b22).</p>	<ul style="list-style-type: none"> • Fan starts up • Fault is reset • ASD runs with the previous installation-specific settings • FW upgrade is completed
<p>(9)</p> <p>Execute a new initial reset from point (7) after a waiting time of at least 5 min. Attention: necessary only if this is expressly mentioned in the concerned firmware description.</p>	<p>According to Sec. 7.3.5</p>	<ul style="list-style-type: none"> • Note the firmware description for the loaded FW • According to Sec. 7.3.5

7.6 Measurements

The ASD supply voltage on terminals 1 and 2 must be checked (if redundant supply, check also terminals 3 and 4). If the set FACP voltage supply is correctly set (not emergency current operation), the voltage must be in the range between 12.3 and 13.8 VDC (when operated in 12 VDC mode) or between 21.6 and 27.6 VDC (when operated in 24 VDC mode). The value depends on the line length. The measured voltage value must be entered in the commissioning protocol following commissioning (see Sec. 7.8).

With the determined and installed conductor cross-section as described in Sec. 4.9.2, this voltage range must always be present when the electrical installation is completed (i.e. on the ASD 535) so that the ASD 535 operates trouble-free (see Sec. 4.9.2).











Notice

If the measured value is outside the specified range, the ASD 535 may malfunction or even become damaged (over 30 VDC).

Voltage values that are too low can be caused by insufficiently dimensioned conductor cross-sections or incorrectly set FACP voltage.

7.6.1 Reading out the set configuration and airflow

Besides measuring the supply voltage on the ASD 535, the set configuration (selected switch settings **A11** to **C32** and **W01** to **W48** when commissioning according to Sec. 4.4.4.3 or parameterized switch settings **X01** to **X03**) as well as the airflow values (rate of airflow change from the time of the initial reset) must be recorded and entered in the commissioning protocol (see Sec. 7.8).

Measure	Display/indication	Procedure/comment
(1)  Briefly press key	flashing, e.g. b22 or other	<ul style="list-style-type: none"> When commissioning, display of the switch settings A11 to C32, W01 to W48, X01 to X03
(2)  Press the key again until the display is on V	in succession A / b / C / E / F / I / o / T / U / V	<ul style="list-style-type: none"> Displays the switch position group V
(3)  Press key	V01	<ul style="list-style-type: none"> Selects the volume rate of flow measurement for sampling pipe I
(4)  Press the key again	flashing after approx. 2 s, e.g. 099	<ul style="list-style-type: none"> Display airflow for sampling pipe I = 99 % of initial reset (initial reset = 100 %)
(5)  for ASD 535-2 and -4: Press the key again until the display is on V	in succession A / b / C / E / F / I / o / T / U / V	<ul style="list-style-type: none"> Displays the switch position group V
(6)  Press key	V01	<ul style="list-style-type: none"> Selects the volume rate of flow measurement for sampling pipe I
(7)  Press key	V02	<ul style="list-style-type: none"> Selects the volume rate of flow measurement for sampling pipe II
(8)  Press key	flashing after approx. 2 s, e.g. 098	<ul style="list-style-type: none"> Display airflow for sampling pipe II = 98 % of initial reset (initial reset = 100 %)

Meaning: Value < 100% = direction pipe blockage / > 100% = direction pipe breakage



Notice

According to EN 54-20 a change in the airflow that is greater than $\pm 20\%$ must be reported as a fault. After an initial reset, the airflow shows 100% in the ASD 535 aspirating smoke detector when the sampling pipe is correct and clean. A fault is triggered in switch settings **A11** to **C32** if the changed value is greater than $\pm 20\%$ (i.e. below 80% or above 120%) and when the LS-Ü delay time exceeds 300 s.

7.7 Testing and checking

In addition to the sampling pipe checks described in Sec. 7.1, the correct transmission of alarms (zone and line) to the FACP when faults or alarms are triggered on the ASD 535 have to be checked. These tests are to be entered in the commissioning protocol (see Sec. 7.8).



Notice

Block or deactivate fire incident control and remote alerting on the superordinate FACP.

- ① Between each check the ASD 535 must be reset (preferably on the FACP, since the reset on the ASD does not reset the FACP). Likewise, after the tests the original state of the sampling pipe has to be restored (open taped sampling holes, close maintenance holes).
- ② For the ASD 535-2 and ASD 535-4 checks have to be carried out for both sampling pipes.

Alternatively, this control can also be performed using the “Test trigger” function from *EasyConfig* (see Sec. 7.7.2).

Test event	Procedure	Action
Checking the airflow monitoring ① / ②	Tape sampling holes (adhesive tape); number depends on the pipe configuration	<ul style="list-style-type: none"> • As soon as the resulting change in the airflow is exceeded by $\pm 20\%$ (can be checked via the switch setting V according to Sec. 7.6.1), the “Fault” LED begins to flash. • When the LS-Ü delay expires (300 s), the ASD triggers a fault → fault on FACP.
Check alarm triggering ① / ②	Subject maintenance sampling hole or sampling hole to smoke, see Sec. 7.7.1	<ul style="list-style-type: none"> • ASD triggers an alarm → alarm on FACP; alarm is checked for correctness (zone and range triggering) on the FACP. • If there are pre-signals they are also actuated

7.7.1 Checking alarm triggering

When **commissioning** and after any changes (repairs) to the sampling pipe, alarm triggering **must** take place on the **last sampling hole** for each pipe branch. This tests the uniformity throughout the entire sampling pipe.

To test alarm triggering during regular **maintenance and service work**, the ASD 535 can be made to actuate on the **maintenance sampling hole**. Because the sampling pipes are continuously monitored for proper functioning, testing via the sampling pipe is normally not necessary. After a test, the maintenance sampling hole has to be closed again (adhesive tape or maintenance clip).

If testing via the maintenance sampling hole is inadequate, testing can be carried out via the sampling pipe as follows:

- Point-by-point testing of the sampling holes. Individual and multiple sampling holes are directly subjected to smoke. Wax/joss sticks are suitable for this.
- Area testing of the sampling pipe. Area testing of the sampling pipe by means of fire testing is advisable and feasible only as it concerns EN 54-20.



Danger

If actual fire testing is to be carried out, responsible local authorities (fire brigade) and trained specialists (manufacturer) must be consulted beforehand.

7.7.2 Test triggerings



Notice about test triggerings

Fire incident control and remote alerting must be blocked or deactivated on the superordinate FACP.

















The “**Test pre-signal**” and “**Test alarm 2**” functions can also be triggered with a non-parameterised event.

- ① Reset the ASD 535 between each check (preferably on the FACP, as a reset on the ASD does not reset the FACP).
- ② On the ASD 535-2 / -4 the checks for both smoke sensors (channels) have to be carried out (on ASD 535-1 / -3, steps (5) to (8), (13) to (16), (21) to (24) and (29) to (32) do not appear in the workflow).

Measure	Display	Procedure / remarks
(1) Press key	flashing C31 or other	• Displays the default setting or the installation-specific switch position
(2) Test alarm channel I Press the key again until the display is on I	in succession A / b / C / E / F / I	• Displays switch position group I
(3) Press key > IA1	IA1 (possible selection here: IA1 / IA2 / IF1 / IF2 / IP1 / IP2 / IE1 / IE2)	• Displays test mode “Test alarm from <i>EasyConfig</i> ”
(4) Press key 3 x	flashing IA1 (until reset)	• ASD 535 triggers Alarm → via relay or XLM to FACP → reset from FACP ①
(5) ② Test alarm channel II Press the key several times until display on I	in succession A / b / C / E / F / I	• Displays switch position group I
(6) Press key	IA1	• Displays test mode “Test alarm from <i>EasyConfig</i> ” for channel I
(7) Press the key again until the display is on IA2	in succession IA1 / IA2	• Displays test mode “Test alarm from <i>EasyConfig</i> ” for channel II
(8) Press key 3 x	flashing IA2 (until reset)	• ASD 535 triggers Alarm → via relay or XLM to FACP → reset from FACP ①
(9) Test fault channel I Press key again until display on I	in succession A / b / C / E / F / I	• Displays switch position group I
(10) Press key	IA1	• Displays test mode “Test alarm from <i>EasyConfig</i> ” for channel I
(11) Press the key several times until display on IF1	in succession IA1 / IA2 / IF1	• Displays test mode “Test alarm from <i>EasyConfig</i> ” for channel I
(12) Press key 3 x	flashing IF1 (until reset)	• ASD 535 triggers fault → via relay or XLM to FACP → reset from FACP ①
(13) Test fault channel II Press key again until display on I	in succession A / b / C / E / F / I	• Displays switch position group I
(14) Press key	IA1	• Displays test mode “Test alarm from <i>EasyConfig</i> ” for channel I
(15) Press the key several times until display on IF1	in succession IA1 / IA2 / IF1 / IF2	• Displays test mode “Test alarm from <i>EasyConfig</i> ” for channel II
(16) Press key 3 x	flashing IF1 (until reset)	• ASD 535 triggers fault → via relay or XLM to FACP → reset from FACP ①



Continuation:

Measure	Display	Procedure / remarks
(17)  Test pre-signal channel I Press key again until display on I	in succession A / b / C / E / F / I	<ul style="list-style-type: none"> Displays switch position group I
(18)  Press key	IA1	<ul style="list-style-type: none"> Displays test mode "Test alarm from <i>EasyConfig</i>" for channel I
(19)  Press the key several times until display on IP1	in succession IA1 / IA2 / IF1 / IF2 / IP1	<ul style="list-style-type: none"> Displays test mode "Test pre-signal from <i>EasyConfig</i>" for channel I
(20)  Press key 3 x	flashing IP1 (until reset)	<ul style="list-style-type: none"> ASD 535 triggers pre-signal → via relay or XLM to FACP → reset from FACP ①
(21)  Test pre-signal channel II Press key again until display on I	in succession A / b / C / E / F / I	<ul style="list-style-type: none"> Displays switch position group I
(22)  Press key	IA1	<ul style="list-style-type: none"> Displays test mode "Test alarm from <i>EasyConfig</i>" for channel I
(23)  Press the key several times until display on IP2	in succession IA1 / IA2 / IF1 / IF2 / IP1 / IP2	<ul style="list-style-type: none"> Displays test mode "Test pre-signal from <i>EasyConfig</i>" for channel II
(24)  Press key 3 x	flashing IP2 (until reset)	<ul style="list-style-type: none"> ASD 535 triggers pre-signal → via relay or XLM to FACP → reset from FACP ①
(25)  Test alarm 2 channel I Press key again until display on I	in succession A / b / C / E / F / I	<ul style="list-style-type: none"> Displays switch position group I
(26)  Press key	IA1	<ul style="list-style-type: none"> Displays test mode "Test alarm from <i>EasyConfig</i>" for channel I
(27)  Press the key several times until display on IE1	in succession IA1 / IA2 / IF1 / IF2 / IP1 / IE1	<ul style="list-style-type: none"> Displays test mode "Test alarm 2 from <i>EasyConfig</i>" for channel I
(28)  Press key 3 x	flashing IE1 (until reset)	<ul style="list-style-type: none"> ASD 535 triggers Alarm 2 → via relay or XLM to FACP → reset from FACP ①
(29)  Test alarm 2 channel II Press key again until display on I	in succession A / b / C / E / F / I	<ul style="list-style-type: none"> Displays switch position group I
(30)  Press key	IA1	<ul style="list-style-type: none"> Displays test mode "Test alarm from <i>EasyConfig</i>" for channel I
(31)  Press the key several times until display on IE2	in succession IA1 / IA2 / IF1 / IF2 / IP1 / IE1 / IE2	<ul style="list-style-type: none"> Displays test mode "Test alarm 2 from <i>EasyConfig</i>" for channel II
(32)  Press key 3 x	flashing IE2 (until reset)	<ul style="list-style-type: none"> ASD 535 triggers Alarm 2 → via relay or XLM to FACP → reset from FACP ①

7.8 Commissioning protocol

When the ASD 535 is delivered, a commissioning protocol (foldout) is included in the package. All of the measurements and tests carried out during commissioning and maintenance must be entered in it and signed.



Notice

- When performing maintenance work or after certain other events, conclusions can be drawn concerning the commissioning state of the ASD 535 based on the commissioning protocol. The protocol also serves as a kind of life history of the ASD 535.
- The commissioning protocol is to be filled out conscientiously and completely and stored in the ASD 535. If required, a copy can be made and stored in the installation dossier.

8 Operation



Warning

The following points must be observed when operating the ASD 535 aspirating smoke detector:

- The performance of this system is dependent upon the sampling pipe. Any extensions or modifications to the designed installation may cause improper operation. The operational effects of such changes shall be verified. Section 4 (planning) must be considered in any case. The Calculation software “ASD PipeFlow” is available from the manufacturer.

8.1 Indication and control elements

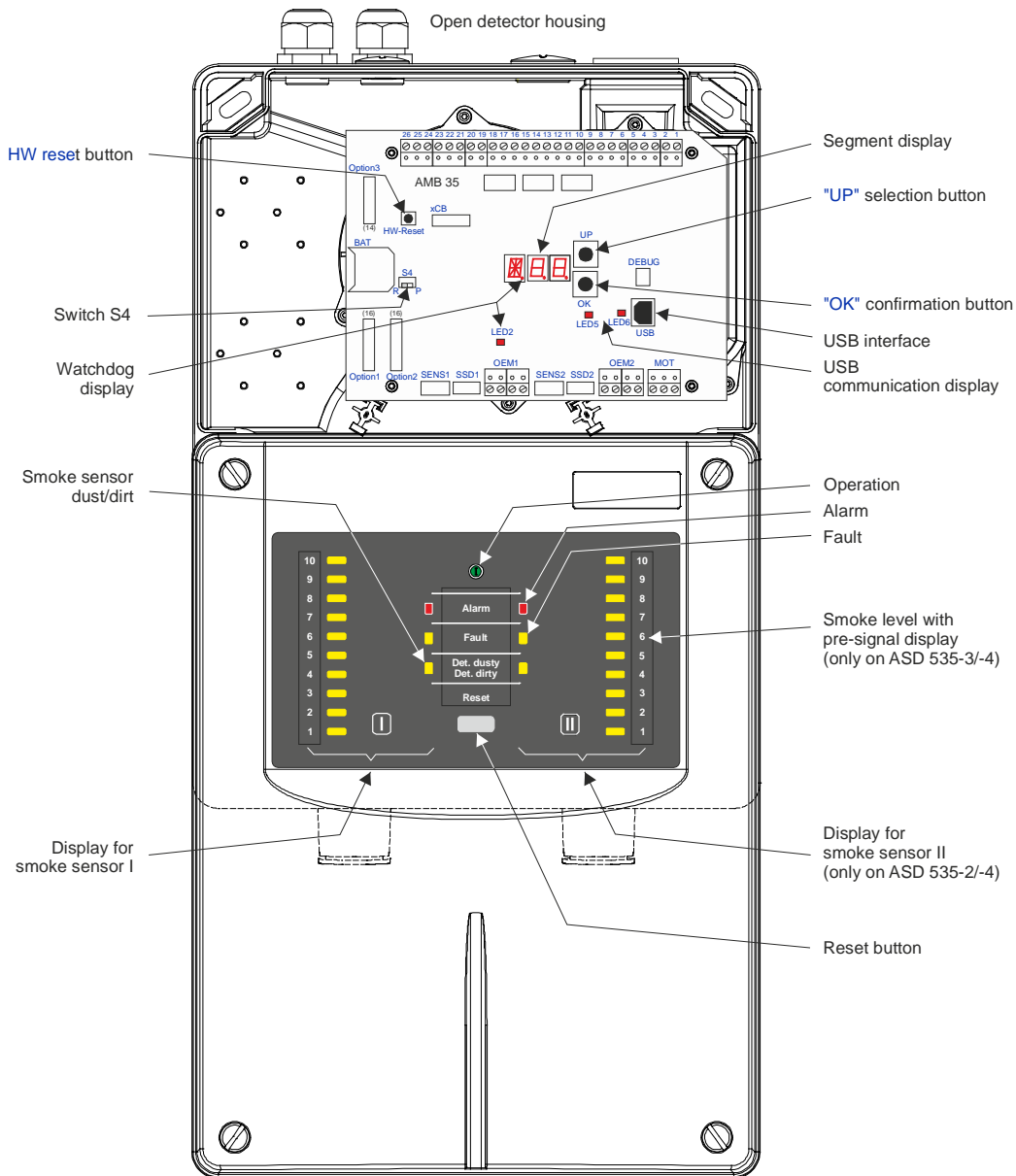

Fig. 47 View of the indication and control elements

The “Reset” button on the control unit is for resetting triggered events (alarms, faults) directly on the ASD 535.

Two 7-segment displays, an alphanumeric display, and two buttons (“UP” / “OK”) are inside the device on the AMB 35 [Main Board](#).

8.2 Functional sequence of operation

The operation of the ASD 535 aspirating smoke detector in normal mode (after commissioning) is limited to switching On/Off or resetting a triggered event (alarm/fault). Operation is generally by means of the FACP, with input of the “Zone On/Off” and “Reset” functions (on “Reset external” input of the ASD 535).

Triggered events on the ASD 535 can be reset locally with the “Reset” button on the control unit or by briefly actuating the “Reset external” input. The reset can be performed only if the triggered event is no longer pending (e.g. smoke sensor no longer has smoke). The application of a continuous signal at the “Reset external” input also deactivates (switches off) the ASD 535 (in this context, see also Sec. 2.2.6 and 6.6.2).

	Notice
Local resetting does <u>not</u> reset a superordinate FACP. It may happen that the superordinate line of the FACP may trigger a fault as a result of the reset process in the ASD 535.	

To aid commissioning the ASD 535, there are two 7-segment displays, an alphanumeric display, and two buttons (“UP” and “OK”) inside the device on the AMB 35 **Main Board**. These elements render a kind of rotary switch function, i.e. indicators/displays and positions can appear in the range of **A00** to **Z99**.

Commissioning the ASD 535 can be performed with these elements. Device settings for pre-defined system limits can also be called up (**EasyConfig**). These pre-defined settings contain normative values concerning response sensitivity, airflow monitoring (LS-Ü) and pipe configuration. They also contain settings which allow deviations from the normative limits concerning airflow monitoring. The **EasyConfig** procedure makes it possible to commission the device without the “ASD Config” configuration software. If system-specific programming has to be performed (e.g. after a calculation with “ASD PipeFlow” or when programming RIM 35), the “ASD Config” configuration software must be used.

8.3 Switch settings

The switch settings which can be called up via the segment display and the “UP” / “OK” buttons on the AMB 35 are listed below. Using the switch settings, entries can be effected (**A / b / C / I / o / T / U / W / X**) and queries can be made (**E / F / V**).

The rotary switch procedure is configured with a **timeout** (approx. 5 s). If within this time period a process is not continued or performed, it is cancelled and the segment display returns automatically to the normal state (flashing point).

Pos.	Range / Display	Purpose	Meaning / Procedure ①
A	A11 / A12	Normative system limits compliant to EN 54-20, Class A	see Sec. 4.4.4.3 and 7.3.3
b	b11 / b12 / b21 / b22	Normative system limits compliant to EN 54-20, Class B	see Sec. 4.4.4.3 and 7.3.3
C	C11 / C12 / C21 / C22 / C31 / C32	Normative system limits compliant to EN 54-20, Class C	see Sec. 4.4.4.3 and 7.3.3
E	E01 to E99 ↳ G00 to G99	Event memory, 99 events (E01 = last event) ↳ Event group G00 to G99	see Sec. 8.5.3
F	F00 to F99 (3 x)	Display of firmware version	see Sec. 7.3.6
I	IA1 IF1 IP1 IE1	Trigger (Initiate); Test alarm (IA.), up to the FACP Test fault (IF.), up to the FACP Test pre-signal (IP.), up to the FACP Test alarm 2 (IE.), up to the FACP Smoke sensor I (..1), smoke sensor II (..2)	see Sec. 7.7.2
o	o00	Log off (all at the same time) optional expansion modules	see Sec. 7.3.7
T	Y10 to Y99 / M01 to M12 d01 to d31 / H00 to H23 M00 to M59	Poll (Read = RE) and adjust (Set = SE) the date and time	see Sec. 7.3.4
U	U01	Execute initial reset	see Sec. 7.3.5
V	V01 / V02 , each 000 to 255	Output of airflow rate in % tube I (= V01), tube II (= V02)	see Sec. 7.6.1
W	W11 to W48	Non-normative system limits	see Sec. 4.4.4.4 and 7.3.3
X	X01 to X03	Configurable switch settings	see Sec. 7.2.1

	Notice
① The table lists only the available switch settings. A detailed description of the operator functions (entry procedure) is in the relevant section (in the “Meaning / Procedure” column).	

8.4 Resetting

Resetting the ASD 535 after a triggered event can be performed by:

- Pressing the “Reset” button on the ASD locally, or
- Briefly actuating the “Reset external” input on the ASD.



Notice

- Resetting can be triggered only after an event, but only if the criterion that resulted in the event trigger is in the normal state again (e.g. smoke level in the smoke sensor is again below the trigger threshold or a fault event is rectified). As a result of resetting, the ASD 535 continues to run “normally” and the fan does not stop.
- Local resetting (“Reset” button) does not reset a superordinate FACP. It may happen that the superordinate line of the FACP may trigger a fault as a result of the reset process in the ASD 535.

8.5 Indicators

8.5.1 Indicators on the control unit

Several LEDs on the control unit indicate the current state of the ASD 535. The table below lists only the states for the ASD 535-1 and ASD 535-3 (one smoke sensor / one sampling pipe). For the ASD 535-2 and ASD 535-4 the indicators are doubled (I and II, see Fig. 47), except the operation indicator.

Function / state	Display/indication				
	Operation	Alarm	Fault	Det. dusty Det. dirty	① Smoke level 1 to 10
	green	red	yellow	yellow	yellow
System Off (no voltage)					
System inactive (reset external)	On		½ s T		
Smoke sensor Off (from FACP)	On		½ s T		
Idle state	On				
Pipe blockage / pipe breakage, delay time running ②	On		1 s T		
Pipe blockage / pipe breakage, fault triggered	On		On		
Fan tachometer signal lacking	On		On		
Fault triggered	On		On		
Pre-signal 1 (ASD 535-1 / -2)	On	2 s T			
Pre-signal 2 (ASD 535-1 / -2)	On	1 s T			
Pre-signal 3 (ASD 535-1 / -2)	On	½ s T			
Smoke level 1 to 10 (ASD 535-3 / -4) ③	On				On
Pre-signal 1, 2 or 3 (ASD 535-3 / -4) ③	On				1 s T
Alarm	On	On			
Dusty smoke sensor	On			1 s T	
Dirty smoke sensor	On			½ s T	
Smoke sensor fault	On			On	



Notice

- ① Additional for ASD 535-3 and ASD 535-4
 - ② No fault triggered (triggers only after the delay time expires → “Fault” LED display continuously lit).
 - ③ The LED of the respective smoke level 1–10 (corresponds to 10–100% of alarm threshold) is continuously lit when exceeded. If a pre-signal is programmed on this level, the LED subsequently begins to flash (default: VS 1 = level 3, VS 2 = level 5, VS 3 = level 7).
- T = Flashing indicator; ½ s cycle / 1 s cycle / 2 s cycle

8.5.2 Indicators on the AMB 35 Main Board

On the AMB 35 [Main Board](#), besides the segment display, there are various LEDs which have the following meaning (see also [Fig. 47](#)):

- Flashing point in the left segment display = watchdog display (processor is running)
- Flashing point and **AL** in the segment display = Autolearning running
- Left flashing point and right point continuously lit in the segment display = day/night control active (only in **X01 – X03**)
- LED 2 = watchdog display (processor not running → ASD has triggered a fault)
- LED 5 = USB interface communication, RX signal, flashing
- LED 6 = USB interface communication, TX signal, flashing

Other output and display possibilities on the segment display are:

- In switch setting **E** = event memory, see Sec. 8.5.3
- In switch setting **F** = firmware version, see Sec. 7.3.6
- Pushbutton “UP” = set configuration (**A11 to C32, W01 to W48, X01 to X03**), see Sec. 7.6.1
- In switch setting **V** = airflow values (airflow rate), see Sec. 7.6.1.





8.5.3 Displaying and reading out the event memory

The event memory can be called up via switch setting **E**. The last 99 events (event location **E01 to E99**) of the overall 430 possible events can be accessed in it. Event location **E01** always contains the last (most recent) event. The entire event memory can be deleted only by the manufacturer.

To display the events by means of the 3 digits of the segment display, the events are divided into groups (**G00 to G99**). For each event group, up to 8 events can be displayed as a 3-digit code. The codes are added together and displayed when there are multiple pending events per event group

8.5.3.1 Procedure and interpretation of the event memory display

The sequence below provides an example to demonstrate how the next to last event, i.e. second youngest, is read out (**E02**). The event displays that smoke sensor I triggered an alarm.

Measure	Display/indication	Procedure/comment
(1)  Briefly press key	flashing, e.g. b22 or other	• Displays the switch position selected at commissioning A11 to C32, W01 to W48, X01 to X03
(2)  Press the key again until display on E	in succession A / b / C / E	• Displays the switch position group E
(3)  Press key	E01	• Selects event E01 (last, i.e. most recent)
(4)  Press key	E02	• Selects event E02 (second last)
(5)  Press key	flashing after approx. 2 s, e.g. G10	• Displays the event group G10 , smoke sensor I events
(6) Wait	flashing after approx. 2 s, e.g. 001 ①	• Displays event codes 001 , smoke sensor I alarm

Notice

 ① **Multiple codes:** If pre-signals 1 to 3 preceded the smoke sensor I alarm triggering, code **057** is displayed as a result at point (6). This is composed (added together) of the following individual codes: **001** (alarm), **008** (pre-signal 1), **016** (pre-signal 2) and **032** (pre-signal 3).

Please refer to Sec. 8.5.3.2 and 8.5.3.3 for a list of all event groups and their events (codes).

8.5.3.2 Event groups

Event group	Purpose
G00	General events, part 1 (ASD On/Off, inactive, start initial reset, smoke sensor ON/OFF from FACP)
G01	General events, part 2 (time, Autolearning, event memory clearing)
G02	General events, part 3 (smoke sensor ON/OFF via "ASD Config")
G03	General events, part 4 (configuration change)
G04	General events, part 5 (reset events)
G10	Smoke sensor I events (alarm, dust/dirt, pre-signals, alarm 2)
G11	Smoke sensor I faults, part 1 (communication to ASD)
G12	Smoke sensor I faults, part 2 (smoke sensor events)
G13	Isolate smoke sensor I (Off/On, test events)
G14	Smoke sensor I Test trigger from EasyConfig to FACP
G15	Smoke sensor I Test trigger from „ASD Config“to FACP
G20	Smoke sensor II events (alarm, dust/dirt, pre-signals, alarm 2)
G21	Smoke sensor II faults, part 1 (communication to ASD)
G22	Smoke sensor II faults, part 2 (smoke sensor events)
G23	Isolate smoke sensor II (Off/On, test events)
G24	Smoke sensor II Test trigger from EasyConfig to FACP
G25	Smoke sensor II Test trigger from „ASD Config“to FACP
G30	Airflow monitoring sampling pipe I (pipe blockage, pipe breakage, LS-Ü parameters, airflow sensor def./lacking)
G40	Airflow monitoring sampling pipe II (pipe blockage, pipe breakage, LS-Ü parameters, airflow sensor def./lacking)
G50	Fan faults (tacho signal, regulator, current consumption)
G60	Initial reset faults (various initial reset parameters, initial reset timeout , airflow too low)
G70	RIM 1, RIM 2 faults
G71	SLM / XLM faults
G72	BCB, ACB faults
G73	MCM / SIM faults
G80	AMB faults (operating system, undervoltage, clock, Autolearning, day/night control)

8.5.3.3 Event codes within the event groups

G00, general events, part 1	
001	Switch on ASD (supply voltage)
002	Initial reset executed (ASD)
004	ASD switched off (inactive, via "Reset external")
008	ASD switched on (via "Reset external")
016	Smoke sensor I switched off from FACP (SecuriPro – SecuriFire – Integral)
032	Smoke sensor II switched off from FACP (SecuriPro – SecuriFire – Integral)
064	Smoke sensor I switched on from FACP (SecuriPro – SecuriFire – Integral)
128	Smoke sensor II switched on from FACP (SecuriPro – SecuriFire – Integral)
G01, general events, part 2	
001	Date and time set
002	Autolearning start
004	Autolearning completed Ok
008	Autolearning cancelled
016	Event memory deleted
032	Initial reset via „ASD Config“
064	Initial reset via FACP
G02, general events, part 3	
001	Smoke sensor I deactivated via "ASD Config"
002	Smoke sensor II deactivated via "ASD Config"
004	Smoke sensor I activated via "ASD Config"
008	Smoke sensor II activated via "ASD Config"
032	Smoke sensor II switched off (partial planning)
128	Smoke sensor II switched on (partial planning)

G03, general events, part 4, Configuration changes													
000	X01	009	C11	018	W04	027	W13	036	W22	045	W31	054	W40
001	X02	010	C12	019	W05	028	W14	037	W23	046	W32	055	W41
002	X03	011	C21	020	W06	029	W15	038	W24	047	W33	056	W42
003	A11	012	C22	021	W07	030	W16	039	W25	048	W34	057	W43
004	A12	013	C31	022	W08	031	W17	040	W26	049	W35	058	W44
005	b11	014	C32	023	W09	032	W18	041	W27	050	W36	059	W45
006	b12	015	W01	024	W10	033	W19	042	W28	051	W37	060	W46
007	b21	016	W02	025	W11	034	W20	043	W29	052	W38	061	W47
008	b22	017	W03	026	W12	035	W21	044	W30	053	W39	062	W48
G04, general events, part 5, reset events													
001	Key												
002	SecuriLine												
004	PC program " ASD Config "												
008	External												
G10, smoke sensor I events													
001	Smoke sensor I alarm												
002	Smoke sensor I dusty												
004	Smoke sensor I dirty												
008	Pre-signal 1 smoke sensor I												
016	Pre-signal 2 smoke sensor I												
032	Pre-signal 3 smoke sensor I												
064	Alarm 2 smoke sensor I												
G11, smoke sensor I faults, part 1													
001	Communication ASD <> smoke sensor I												
002	Unknown smoke sensor type, smoke sensor I												
004	Response sensitivity too low, smoke sensor I												
008	Invalid parameters, smoke sensor I												
G12, smoke sensor I faults, part 2													
001	Smoke sensor I sampling chamber												
002	Temperature, smoke sensor I												
004	Supply voltage, smoke sensor I												
008	EEPROM access fault, smoke sensor I												
016	EEPROM invalid data, smoke sensor I												
032	Manufacture, smoke sensor I												
G13, isolate smoke sensor I													
001	Isolated smoke sensor I alarm												
002	Isolate smoke sensor I switched on												
004	Isolate smoke sensor I switched off (normal operation)												
008	Isolated pre-signal 1, smoke sensor I												
016	Isolated pre-signal 2, smoke sensor I												
032	Isolated pre-signal 3, smoke sensor I												
064	Isolated alarm 2, smoke sensor I												
G14, smoke sensor I test trigger from <i>EasyConfig</i> to FACP													
G15, smoke sensor I test trigger from "<i>ASD Config</i>" to FACP													
001	Alarm test, smoke sensor I												
002	Fault test, smoke sensor I												
004	Pre-signal 1 test, smoke sensor I												
008	Pre-signal 2 test, smoke sensor I												
016	Pre-signal 3 test, smoke sensor I												
032	Test alarm 2, smoke sensor I												

→→

Continuation:

G20, smoke sensor II events	
001	Smoke sensor II alarm
002	Smoke sensor II dusty
004	Smoke sensor II dirty
008	Pre-signal 1 smoke sensor II
016	Pre-signal 2 smoke sensor II
032	Pre-signal 3 smoke sensor II
064	Alarm 2 smoke sensor II
G21, smoke sensor II faults, part 1	
001	Communication ASD <> smoke sensor II
002	Unknown smoke sensor type, smoke sensor II
004	Response sensitivity too low, smoke sensor II
008	Invalid parameters, smoke sensor II
G22, smoke sensor II faults, part 2	
001	Smoke sensor II sampling chamber
002	Temperature, smoke sensor II
004	Supply voltage, smoke sensor II
008	EEPROM access fault, smoke sensor II
016	EEPROM invalid data, smoke sensor II
032	Manufacture, smoke sensor II
G23, smoke sensor II Isolate	
001	Isolated smoke sensor II alarm
002	Isolate smoke sensor II switched on
004	Isolate smoke sensor II switched off (normal operation)
008	Isolated pre-signal 1, smoke sensor II
016	Isolated pre-signal 2, smoke sensor II
032	Isolated pre-signal 3, smoke sensor II
064	Isolated alarm 2, smoke sensor II
G24, smoke sensor II test trigger from EasyConfig to FACP	
G25, smoke sensor II test trigger from "ASD Config" to FACP	
001	Alarm test, smoke sensor II
002	Fault test, smoke sensor II
004	Pre-signal 1 test, smoke sensor II
008	Pre-signal 2 test, smoke sensor II
016	Pre-signal 3 test, smoke sensor II
032	Test alarm 2, smoke sensor II
G30, airflow monitoring sampling pipe I	
001	Pipe blockage, sampling pipe I
002	Pipe breakage, sampling pipe I
004	Invalid LS-Ü parameters, sampling pipe I
008	Airflow sensor I, defective / lacking
G40, airflow monitoring sampling pipe II	
001	Pipe blockage, sampling pipe II
002	Pipe breakage, sampling pipe II
004	Invalid LS-Ü parameter, sampling pipe II
008	Airflow sensor II, defective / lacking
G50, fan faults	
001	Tacho signal lacking
002	Motor regulation outside of range
004	Motor current too low
G60, initial reset faults	
001	Initial reset value I, airflow too low
002	Initial reset value II, airflow too low
004	Initial reset Timeout
008	Invalid parameters for initial reset I
016	Invalid parameters for initial reset II
032	Motor speed during initial reset outside range
064	Initial reset value I, airflow too high
128	Initial reset value II, airflow too high

→→

Continuation:

G70, RIM 1 / RIM 2 faults	
001	RIM 1 fault
016	RIM 2 fault
G71, SLM / XLM faults	
001	SLM fault
004	SLM fault, to many SLMs
016	XLM fault
064	XLM fault, to many XLMs
G72, BCB / ACB faults	
001	BCB fault
016	ACB fault
G73, MCM / SIM faults	
001	MCM fault, lacking or defective
002	MCM fault, communication fault
004	MCM fault, too many MCMs
016	SIM fault
064	SIM fault, to many SIMs
G80, AMB faults	
001	Operating system fault 1
002	Operating system fault 2
004	Undervoltage fault
008	Clock fault
016	EEPROM fault
032	Invalid parameters, Autolearning
064	Invalid parameters, day/night control

8.5.4 Indication and controls on the XLM or SLM 35

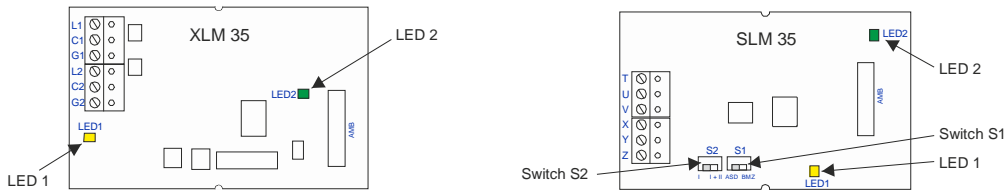

Fig. 48 XLM 35 / SLM 35 indication and control

The **SLM 35** SecuriLine module has two switches (S1 and S2) with the following functions (only SLM 35):

Switch S1	ASD / FACP control access
ASD position	Re-programming is possible only on the ASD; state query is possible from FACP
BMZ position	Re-programming and state query possible from FACP and ASD
Switch S2	Number of smoke sensors in the ASD
Position I	ASD 535-1, -3 with 1 smoke sensor, on the FACP only as one zone
Position I + II	ASD 535-2, -4 with 2 smoke sensors, on the FACP side as V-AI / H-AI or AI zone A / AI zone B

The 2 LEDs on the **XLM 35** or **SLM 35** show the communication state.

LED 1 (yellow)	State XLM 35 / SLM 35 ↔ addressable loop (lights only if supply from AMB is Ok)
Not lit	No addressable loop voltage
Continuously lit	Addressable loop voltage Ok, no communication XLM / SLM ↔ Line
Flashes (normal operation)	Communication XLM / SLM ↔ Line Ok
LED 2 (green)	State ASD 535 ↔ XLM / SLM 35
Not lit	No power supply from AMB 35
Flashes (normal operation)	Supply from AMB 35 Ok, communication XLM / SLM ↔ ASD Ok

8.5.5 Indication and control on the MCM 35

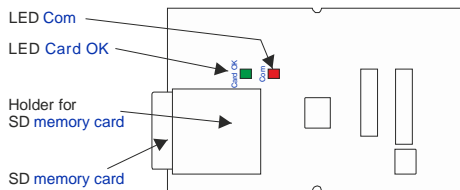

Fig. 49 MCM 35 indication and control

The 2 LEDs on the MCM 35 indicate the communication state of the SD **memory card** and the communication state (writing) from the AMB.

LED card OK (green)	SD memory card state (lights only if supply from AMB is Ok)
Not lit	MCM connection ↔ AMB not Ok, SD memory card not inserted, MCM logged off
Continuously lit	MCM connection ↔ AMB Ok, SD memory card inserted, MCM logged on
LED Com (red)	Communication / Write state
Not lit	No communication from AMB
Flashes (normal operation)	MCM communication ↔ AMB Ok, SD memory card logging.

The MCM 35 and the **SD memory card** are automatically detected when the device is switched on and are monitored from then on. The data logging begins automatically after about 10 s.

Warning

- Using the SD memory card: Before the **SD memory card** is used, make sure that it is empty (interpretation of the files).
- Removing the SD memory card: Before the **SD memory card** can be removed from the MCM 35, the MCM 35 has to be logged off the AMB 35 **Main Board** via operating controls (to prevent data loss). This applies also to subsequent removal of the MCM, e.g. because it is not used (see Sec. 7.3.7).
- Only **industrial SD memory cards** tested and approved by the manufacturer may be used.

The **SD memory card** is inserted with the contact side toward the MCM circuit board up to the stop in the holder until it snaps in. By pressing the **SD memory card** again, the locking mechanism is released and the **SD memory card** can then be pulled out of the holder.

8.5.5.1 Data logging on the MCM 35

Smoke and airflow values: Every second the alarm sensitivity, smoke level, dirt level and airflow values for each smoke sensor are logged and saved in **Log-Files** (.xls file) on the **SD memory card**. After 28,800 entries (corresponds to 8 hours at 1 s MCM interval) a new **Log-File** is generated automatically. A total of 251 **Log-Files** (L000.xls to L250.xls) can be generated for long-term logging. After the last **Log-File** the oldest one (L000.xls) is overwritten. The 251 **Log-Files** cover data logging for 83 days (at 1 s MCM interval). The **Log-Files** can then be opened in Excel and the data can be processed with the diagram assistant to create charts.

Events: All events which occur in the ASD 535 are written to the **Event-Files** (.aev file). After 64,000 events a new **Event-File** is automatically created. A total of 251 **Event-Files** (E000.aev to E250.aev) can be generated for long-term logging. After the last **Event-File** the oldest one (E000.aev) is overwritten. The 251 **Event-Files** are adequate to log over 16 million events. The **Event-Files** can be opened with a text editor. Please refer to Sec. 8.5.3 for interpretation of the events. There is also the possibility of importing **Event-Files** using the configuration software “**ASD Config**” and displaying them as true event text.

8.5.6 Indication and control on the SIM 35

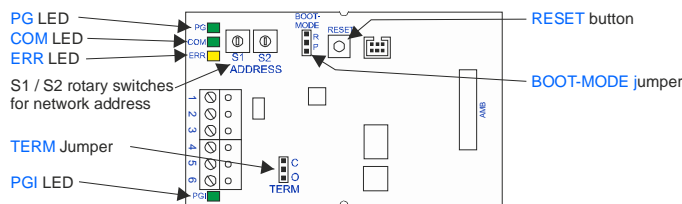

Fig. 50 SIM 35 indication and control

The functions of the rotary switches, jumpers, buttons and LEDs are shown in the following table.

The network address is set in hexadecimal code using the two rotary switches (S1 and S2). The bus termination is defined with the **TERM** jumper. This must be done on **both sides of the network** (beginning and end). The **BOOT-MODE** jumper is used only in production. The **RESET** button initiates a HW reset on the SIM 35. The four LEDs on the SIM 35 indicate the state of the ASD network. Please refer to Sec. 11.6 for more information about the ASD network.

Rotary switch S1 / S2		Network address													
Dec	Hex	Dec	Hex	Dec	Hex	Dec	Hex	Dec	Hex	Dec	Hex	Dec	Hex		
		32	2 0	64	4 0	96	6 0	128	8 0	160	A 0	192	C 0	224	E 0
1	0 1	33	2 1	65	4 1	97	6 1	129	8 1	161	A 1	193	C 1	225	E 1
2	0 2	34	2 2	66	4 2	98	6 2	130	8 2	162	A 2	194	C 2	226	E 2
3	0 3	35	2 3	67	4 3	99	6 3	131	8 3	163	A 3	195	C 3	227	E 3
4	0 4	36	2 4	68	4 4	100	6 4	132	8 4	164	A 4	196	C 4	228	E 4
5	0 5	37	2 5	69	4 5	101	6 5	133	8 5	165	A 5	197	C 5	229	E 5
6	0 6	38	2 6	70	4 6	102	6 6	134	8 6	166	A 6	198	C 6	230	E 6
7	0 7	39	2 7	71	4 7	103	6 7	135	8 7	167	A 7	199	C 7	231	E 7
8	0 8	40	2 8	72	4 8	104	6 8	136	8 8	168	A 8	200	C 8	232	E 8
9	0 9	41	2 9	73	4 9	105	6 9	137	8 9	169	A 9	201	C 9	233	E 9
10	0 A	42	2 A	74	4 A	106	6 A	138	8 A	170	A A	202	C A	234	E A
11	0 B	43	2 B	75	4 B	107	6 B	139	8 B	171	A B	203	C B	235	E B
12	0 C	44	2 C	76	4 C	108	6 C	140	8 C	172	A C	204	C C	236	E C
13	0 D	45	2 D	77	4 D	109	6 D	141	8 D	173	A D	205	C D	237	E D
14	0 E	46	2 E	78	4 E	110	6 E	142	8 E	174	A E	206	C E	238	E E
15	0 F	47	2 F	79	4 F	111	6 F	143	8 F	175	A F	207	C F	239	E F
16	1 0	48	3 0	80	5 0	112	7 0	144	9 0	176	B 0	208	D 0	240	F 0
17	1 1	49	3 1	81	5 1	113	7 1	145	9 1	177	B 1	209	D 1	241	F 1
18	1 2	50	3 2	82	5 2	114	7 2	146	9 2	178	B 2	210	D 2	242	F 2
19	1 3	51	3 3	83	5 3	115	7 3	147	9 3	179	B 3	211	D 3	243	F 3
20	1 4	52	3 4	84	5 4	116	7 4	148	9 4	180	B 4	212	D 4	244	F 4
21	1 5	53	3 5	85	5 5	117	7 5	149	9 5	181	B 5	213	D 5	245	F 5
22	1 6	54	3 6	86	5 6	118	7 6	150	9 6	182	B 6	214	D 6	246	F 6
23	1 7	55	3 7	87	5 7	119	7 7	151	9 7	183	B 7	215	D 7	247	F 7
24	1 8	56	3 8	88	5 8	120	7 8	152	9 8	184	B 8	216	D 8	248	F 8
25	1 9	57	3 9	89	5 9	121	7 9	153	9 9	185	B 9	217	D 9	249	F 9
26	1 A	58	3 A	90	5 A	122	7 A	154	9 A	186	B A	218	D A	250	F A
27	1 B	59	3 B	91	5 B	123	7 B	155	9 B	187	B B	219	D B		
28	1 C	60	3 C	92	5 C	124	7 C	156	9 C	188	B C	220	D C		
29	1 D	61	3 D	93	5 D	125	7 D	157	9 D	189	B D	221	D D		
30	1 E	62	3 E	94	5 E	126	7 E	158	9 E	190	B E	222	D E		
31	1 F	63	3 F	95	5 F	127	7 F	159	9 F	191	B F	223	D F		

Jumper TERM	Bus termination (position “C” = active)
Position O	SIM 535 is not first or last module
Position C	SIM 535 is first or last module
Jumper BOOT-MODE	FW upgrade (production)
Position R	Normal position
Position P	Local FW upgrade on the SIM 35
Button RESET	Reset SIM
Press	Triggers a HW reset of the SIM 35

LED PG (green)	State supply voltage
continuously lit	Supply from AMB 35 Ok
LED PGI (green)	State of internal voltage supply
continuously lit	Internal voltage supply OK
LED COM (green)	State communication
Flashes	Communication running, “ASD Config” is active
LED ERR (yellow)	State SIM / fault
Flashes	Address is in invalid range
continuously lit	SIM has a fault

8.5.7 Indication and control on the SMM 535

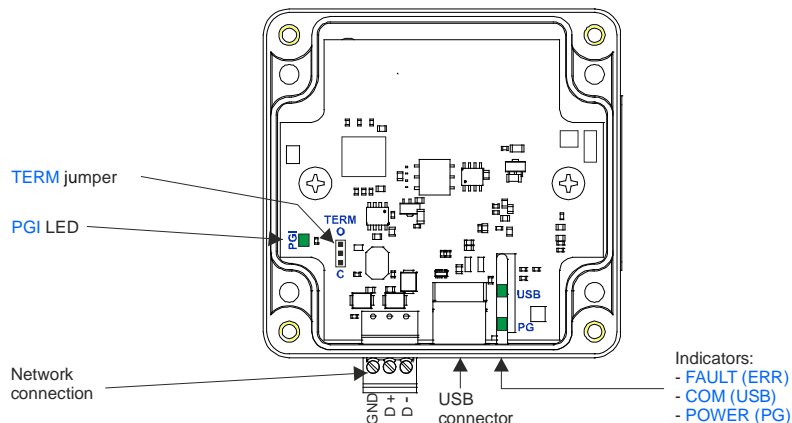

Fig. 51 SMM 535 indication and control

The functions of the jumpers and LEDs are shown in the following table.

The bus termination is defined with the **TERM** jumper. This must be done on **both sides of the network** (beginning and end). The three LEDs on the SMM 535 indicate the state of the ASD network. Two of these are fibre optic cables on the outside of the map case (**FAULT** LED is not included, optional).

Jumper TERM	Bus termination (position "C" = active)
Position O	SMM 535 is not first or last module
Position C	SMM 535 is first or last module
POWER (PG) (green)	State supply voltage
continuously lit	Supply from PC (USB) Ok
COM (USB) (green)	State communication
Flashes	Communication running, "ASD Config" is active
LED PGI (green)	State of internal voltage supply
continuously lit	Internal voltage supply OK

No network address has to be assigned to the SMM 535.

8.6 Control from SecuriPro with SLM 35

When connecting an ASD 535 with a built in **SLM 35** from SecuriPro, the ASD can also be operated via the SecuriPro user interface. The following operations can be carried out (reprogramming from FACP possible only with the switch setting **X01** to **X03** and if the slide switch on the SLM 35 is in the “**BMZ**” position). In position “**ASD**” only a state query is possible (see Sec. 7.4.3):

Command structure	Comment
OPERATIONS ASD535	
MANUAL	General operations
DETECTOR	Object number entry (DA / DZ / DET)
ON STATUS	Switch on ASD
OFF STATUS	Switch off ASD
FACTORY SETTINGS	Restore ASD default values
POLLING OPERATION MODE	State polling
SENSITIVITY SMOKE	
DETECTOR	Object number entry (DA / DZ / DET)
HIGH	Corresponds to 80% of “medium” ①
MEDIUM	Corresponds to sensitivity based on A11 to W48 or “ASD PipeFlow” (= 100%) ①
LOW	Corresponds to 120% of “medium” ①
POLL	State polling
SENSITIVITY AIR FLOW	
DETECTOR	Object number entry (DA / DZ / DET)
HIGH	Corresponds to the ASD configuration ±10% ①
MEDIUM	Corresponds to the ASD configuration ±20%, based on A11 to C32 ①
LOW	Corresponds to the ASD configuration ±50% (range ±30 – ±70%) ①
POLL	State polling
DELAY AIR FLOW	
DETECTOR	Object number entry (DA / DZ / DET)
HIGH	Corresponds to the ASD configuration 20 min (range 11 – 60 min) ①
MEDIUM	Corresponds to the ASD configuration 10 s (range 6 – 10 min) ①
LOW	Corresponds to the ASD configuration 300 s, based on A11 to C32 (range 10 s – 300 s) ①
POLL	State polling

= normative settings according to EN 54-20

Warning

Ⓛ Re-programming from SecuriPro FACP may result in non-compliance with EN 54-20. Any adaptations or modifications to the ASD 535 from the SecuriPro FACP to “low” may be performed only by the manufacturer or by qualified persons trained by the manufacturer (see Sec. 7.4.3).

8.7 Operation from SecuriFire / Integral with XLM 35

(In preparation) When the connection is via an **XLM 35** to the SecuriFire or **Integral** FACP, controls and ASD device configuration changes can be performed directly from the FACP. Also, by means of the FACP operating software “SecuriFire Studio” or “[Integral Application Center](#)”, the “ASD Config” configuration software is launched for accessing the ASDs, enabling operation on the ASD 535.

9 Maintenance and service

9.1 General information



Warning

Maintenance and service work on fire alarm systems are subject in part to country-specific laws and directives.

Maintenance and service work may be performed only by persons trained and authorised by the manufacturer of the ASD 535.

Depending on deployment, the ASD 535 must be serviced at least once a year by the manufacturer or by personnel who have been authorised and trained by the manufacturer. If required (e.g. significant dirt hazard), the service interval is reduced to guarantee functional reliability. If filter boxes and/or filter units are used, the service life of the filter inserts play a role in the service interval. Depending on the level of dust and dirt in the object, filter service may vary greatly. The optimal filter service life is determined on site.

The operator is obligated to conclude a service agreement with the manufacturer or with an installer authorised by the manufacturer if the operator does not have the required service personnel trained by the manufacturer.

The legally prescribed national directives (DIN VDE 0833-1, Cantonal Fire Insurance Union) concerning maintenance must be observed.

Servicing, maintenance or inspection work on the ASD 535 may be necessary after an event (fire, fault).

If a detector housing has to be replaced due to a defect, the new ASD 535 has to undergo first-time commissioning (initial reset required). When replacing an ASD 535, all customer-specific configurations have to be carried out again.

When performing maintenance work and performance checks, the relevant information in the following Sec. (9.3) must be observed.

9.2 Cleaning

The detector housing is cleaned with a **non-aggressive** cleaning agent (e.g. soap and water or similar).

In the sampling pipe tube network, it is normally only necessary to clean the sampling holes. In applications where dirt is a major issue, it may be necessary to clean inside the sampling pipe (blow out with compressed air or nitrogen). Only **non-aggressive** cleaning agents may be used when cleaning the sampling pipe (e.g. soap and water or similar).



Warning

Aggressive cleaning agents (such as solvents, pure petrol or other alcohol-containing agents) must not be used for cleaning.

9.3 Maintenance checks, performance checks



Notice

To prevent triggering fire incident controls, remote alerting and extinguishing areas when maintenance work is performed, it is **absolutely** necessary that they are blocked or switched off beforehand.

Perform the following measures for performance and maintenance checks:

1. Block or switch off fire incident control and remote alerting on superordinate FACP.
2. Check that the supply voltage on the FACP is set in compliance with maintenance instructions for the control unit.
3. Check the sampling pipe inlet and pipe plugs of the unused inlet opening on the detector housing (ASD 535-1 and ASD 535-3) for correct seating.
4. Check the air outlet for dirt and clean if necessary.
5. If the ASD 535 is deployed for equipment monitoring and plug-in transitions from rigid to flexible pipe are present, check that the transitions are properly seated (sealed).
6. Open the cover of the detector housing and fasten it in the middle mounting position of the map case base. **Caution:** flat cable connection (see Sec. 5.4.1 and 7.1). Carry out the following measurements:
 - Measure operating voltage on terminals 1 (+), 2 (-) → target value = 12.3 to 13.8 VDC (in 12 VDC operation) or 21.6 to 27.6 VDC (in 24 VDC operation).
 - Read out airflow value for each sampling pipe in switch setting **V** (see Sec. 7.6.1) and compare with commissioning protocol. If there is a difference of more than half of the set sensitivity (see examples ① and ②), the sampling pipe must be checked as follows:
 - An **increase** in the value (greater than 100%) tends to indicate **pipe breakage** → check the sampling pipe for leaks (junctions, fittings, etc.)
 - A **decrease** in the value (less than 100%) tends to indicate **pipe blockage** → check the sampling pipe for pipe blockage, clean as described in **point 9** resp. **point 10**.
- ① Configured LS-Ü sensitivity = ±20% (standard), half of that = ±10%. The sampling pipe should be checked if the value is below 90% or above 110%.
- ② Configured LS-Ü sensitivity = ±50% (non-compliant with EN 54-20), half of that = ±25%. The sampling pipe should be checked if the value is below 75% or above 125%.
7. Deactivate the ASD (pull off terminal block 1/2 and if necessary 3/4 on the AMB 35), carefully undo the flat cable connection to the control unit and completely remove the cover of the detector housing. After disconnecting the flat cable connections to the smoke sensors, carefully remove them from the ASD.
8. Use a soft, dry brush to clean the inside of the smoke sensor chamber and the insect protection screen. Oil-free compressed air or nitrogen can also be used for cleaning.



Warning

Do not blow out the smoke sensors with compressed air or open them. Improper handling can have an affect the response characteristics. Cleaning dirty smoke sensors may be performed only by the manufacturer. The smoke sensors are monitored for dust and dirt; their states are displayed on the control unit. If necessary, the smoke sensors have to be replaced.

After cleaning the smoke sensor chambers, re-mount the smoke sensors in the ASD.



Continuation:

9. If cleaning the sampling pipe is required as per **point 6**, carry out the following measures (perhaps also **point 10**):
- Clean all sampling holes in the entire sampling pipe tube network. Tobacco pipe cleaners can be used, for example.
 - If the sampling holes are not accessible, the entire sampling pipe tube network can be blown out from the detector housing with oil-free compressed air or nitrogen. This is performed via the manual ball-cock or from the loosened fitting (pipe connection) of the last accessory part in the direction of the sampling pipe tube network.



Warning

Blowing out from inside the smoke sensor chamber (through the fan) can damage the fan and is therefore not permitted.

- If present, open the accessory parts (water separator, filter box / filter unit, detector boxes) and clean with a soft dry brush. Oil-free compressed air or nitrogen can also be used for cleaning. Replace the filter insert in the filter box / filter unit. When finished, close the accessory parts again.
 - After cleaning the sampling pipe, re-connect to the ASD 535.
10. In applications where dirt is a major issue, it may be necessary to clean the air flow sensors. For this purpose (see Sec. 9.4.3) take them out of the holder and clean with a soft, dry brush → **Caution: Do not clean or touch the sensor surface with your fingers.** Afterwards, re-mount the air flow sensors according to Sec. 9.4.3 → ensure they are properly seated in the holder.
11. Connect the flat cable connection to the control unit and fasten the cover of the detector housing to the middle mounting positions of the map case base. Switch on the ASD again and wait until the fan reaches the optimal speed (at least 5 minutes).
12. Check the fault and alarm triggering and the correct alarm triggering on the FACP as described in Sec. 7.7. Enter the performed tests in the commissioning protocol.
13. Read out the airflow values **V** again. If the values in **point 6** are still outside the tolerance range, it is necessary to carry out a new adjustment of the airflow monitoring (initial reset as described in Sec. 7.3.5).



Danger

Following cleaning work on the sampling holes, an initial reset is normally not necessary (cleaning restores the commissioning state). If an initial reset is nevertheless necessary after the work in **point 13**, it may be performed **only** if it is certain that all possible measures for cleaning the sampling pipe have been previously carried out (including new filter insert).

If an initial reset is carried out with blocked sampling holes, there is the danger that insufficient air samples or no air samples will be aspirated and hence the ASD 535 can no longer trigger an alarm.

14. If, as a result of servicing checks, maintenance or repair work is carried out on the ASD 535 (including sampling pipe), a new initial reset may be necessary (see Sec. 7.3.5).
15. All performed measurements and tests are to be entered in the commissioning protocol and signed. Place the filled out commissioning protocol in the ASD. If required, a copy can be made and stored in the installation dossier.
16. After completion of the servicing check, close the detector housing.

9.4 Replacing units



Warning

Replacing defective units such as the AMB 35, smoke sensors, airflow sensors, and fans may be performed only if there is no voltage supply (terminal block 1/2 and if necessary 3/4 pulled out on the AMB 35).

9.4.1 Replacing the smoke sensors

The replacement of a smoke sensor is necessary if it is defective or if there is a dirty message.

Proceed according to Sec. 6.3 when replacing a smoke sensor. It is important to ensure that the new smoke sensor has the same alarm sensitivity range as the old one (SSD 535-1, -2, -3).

9.4.2 Replacing the aspirating fan unit

To replace the AFU 35 aspirating fan unit, the AMB 35 **Main Board** must be removed. This is done by carefully removing all internal cable connections. Remove the three connection wires from the terminals. It is not necessary to pull out plug-in terminals 1 to 26. After removing the fastening screws of the AMB 35 with a **Torx T10 screwdriver**, the AMB 35 can be lifted up toward the cable entries and the fastening screws of the aspirating fan unit are accessible. To remove the aspirating fan unit, remove the five screws **A** with a **Torx T15 screwdriver** (see Fig. 52).



Danger

Screws **B** on the aspirating fan unit must not be removed.



Warning

When connecting the new aspirating fan unit, pay attention to the wire colours (see Fig. 52).

After replacing the aspirating fan unit, a new initial reset is imperative (see Sec. 7.3.5).

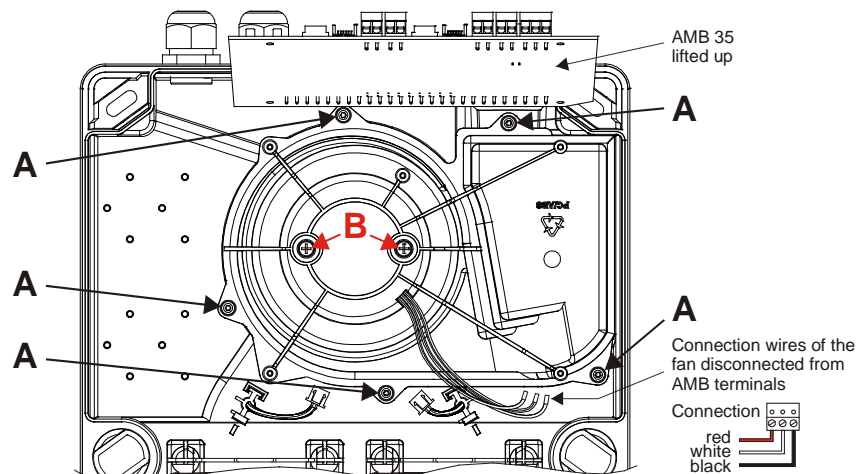

Fig. 52 Removing the aspirating fan unit

9.4.3 Replacing the airflow sensor



Warning

When removing and mounting the airflow sensor, make sure that the sensor element is not damaged (i.e. does not break). Do not pull on the connection wires.

After replacing an airflow sensor (new sensor), a new initial reset is imperative (see Sec. 7.3.5).

Undo connector **A** of the airflow sensor on the AMB 35. To remove an airflow sensor, lock tab **B** must be lightly pressed toward the smoke sensor chamber. The airflow sensor can then be carefully pulled out of the holder by grip tab **C** with thumb and index finger → **Caution: do not pull on the connection wires of the airflow sensor.** Installing the new airflow sensor is performed in the reverse sequence. It is important to note the installation position (anti-twist safeguard) and ensure that the airflow sensor is correctly seated in its holder. To do this, press the airflow sensor on grip tab **C** toward the map case base until the lock tab snaps over the airflow sensor → **Caution: do not press on the connection wires of the airflow sensor.**

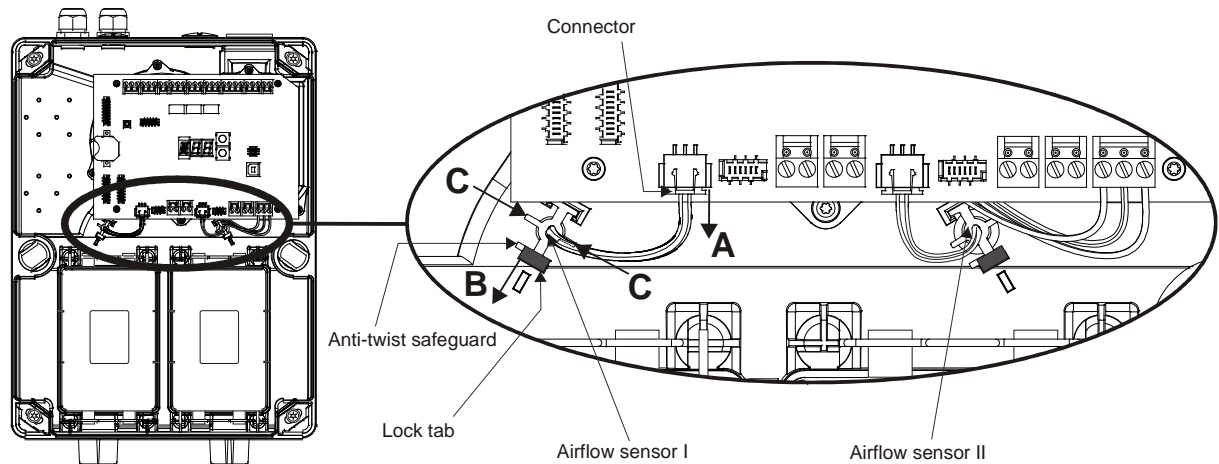

Fig. 53 Removing the airflow sensors

9.4.4 Replacing the AMB 35 Main Board

To replace the AMB 35 **Main Board**, all plug-in terminals with installation wires have to be disconnected. Likewise, all internal cable connections (flat cable connectors) must be carefully pulled out. After removing the 4 fastening screws of the AMB 35 with a **Torx T10 screwdriver**, the AMB 35 can be replaced. Installation of the new AMB 35 is performed in the reverse sequence.



Warning

When connecting the new AMB 35, pay attention to the terminal and flat cable connector assignments (see Fig. 5).

After replacing the AMB 35 a new initial reset is imperative (see Sec. 7.3.5). In addition, all customer-specific configurations and project-specific settings from the "ASD PipeFlow" configuration software must be carried out again. Proceed according to Sec. 7.3.1 and 7.3.2.

9.4.5 Replacing printed circuit boards BCB 35 and ACB 35

To replace printed circuit boards BCB 35 and ACB 35 of the display field, the flat cable connection on the BCB 35 / ACB 35 must be carefully removed. After removing the four fastening screws of the BCB 35 / ACB 35 with a **Torx T10 screwdriver**, replacement can take place. Installation is in the reverse order.

9.5 Disposal

The ASD 535 aspirating smoke detector and its packaging consist of recyclable material that can be disposed of as described in Sec. 9.5.1.

9.5.1 Deployed materials



Environmental protection and recycling

All materials used in the ASD 535 and all technologies used in manufacturing are ecologically and environmentally friendly in compliance with ISO 14000.

All waste resulting from assembly (packaging and plastic parts) can be recycled and should be disposed of accordingly.

No longer used devices, sampling pipes and parts should be disposed of in an environmentally-friendly manner.

The manufacturer of the ASD 535 is obligated to take back defective or no longer used devices and sampling pipes and will dispose of them in an environmentally-friendly manner. For this purpose the manufacturer maintains a monitored and approved disposal system. This service is available worldwide at cost price.

Materials used in the ASD 535:

Detector housing	PC / ABS
Smoke sensor SSD 535	Lexan (PC)
Fan housing / fan wheel	PBTP / PA6
Fan electric motor	PU / Cu / barium ferrite powder
Circuit boards, general	Epoxy resin hard paper
Soldering process	Environmentally-friendly manufacturing compliant with RoHS
Foil on control unit	PE
Sampling tubes	ABS / PA
Fittings	ABS / PA
Clips	PA
ABS glue	ABS / solvent MEK (methyl, ethyl, ketone)



Danger with PVC plastics

Because PVC plastics when burned produce poisonous, corrosive and environmentally damaging combustion products, the use of PVC is not permitted in many applications. The relevant construction regulations must be observed.

Ecology:

PVC plastics cannot be produced and disposed of without taking into consideration the environmental impact. Recycling PVC is only possible to a limited degree. Please refer to preceding danger information.

Sampling tubes	PVC, see danger information above
Fittings	PVC, see danger information above
PVC glue	PVC / solvent tetrahydrofurane, cyclohexanone

10 Malfunctions

10.1 General information

When troubleshooting, no on-site modifications may be performed on the printed circuit boards. This applies in particular to replacing or changing soldered components. Defective printed circuit boards have to be completely replaced; they must be returned to the manufacturer for repair with a repair note specifying the cause of the malfunction.



Warning

Replacing and changing printed circuit boards may be performed only by trained and qualified personnel. Handling must adhere to the measures for safeguarding against electrostatic charges.

10.2 Warranty claims

If the above measures of conduct are not observed, warranty claims and manufacturer liability for the ASD 535 are invalidated.



Danger

- Repairs on the device or parts thereof may be performed only by personnel trained by the manufacturer. Non-observance of this regulation results in the invalidation of warranty claims and the manufacturer's liability concerning the ASD 535.
- All performed repairs and rectified faults are to be documented.
- After a making a repair or rectifying a fault, the ASD 535 must undergo a performance check.

10.3 Finding and rectifying faults

10.3.1 Fault states

With the aid of the event memory and the relevant event code display (can be called up with the segment display on the AMB 35, switch setting **E**), it is possible to localise the error in the event of a fault. The following table lists the event codes of possible fault states and how to rectify them. Because the codes are the same for smoke sensors I and II as well as for LS-Ü I and II, they are listed together. For the interpretation it is therefore important to note the relevant event group (e.g. **G10** or **G20**). A list of all event codes is provided in Sec. 8.5.3.3.



Notice

Multiple codes: If there are multiple events per event group, they are added together in the displays.
Example: Display **012** = event code **004** and **008**.

G10 or G20, smoke sensor I/II events			
Code	Meaning:	Check	Possible causes and rectification
002	Dusty smoke sensor	Check smoke sensor chamber, sampling pipe and filter box / filter unit for dust deposits	<ul style="list-style-type: none"> • Clean inside the smoke sensor chamber and the insect protection screen • Check and clean sampling pipe and if necessary filter box / filter unit • Replace smoke sensor
004	Dirty smoke sensor	Check smoke sensor chamber, sampling pipe and filter box / filter unit for dirt deposits	<ul style="list-style-type: none"> • Clean inside the smoke sensor chamber and the insect protection screen • Check and clean sampling pipe and if necessary filter box / filter unit • Replace smoke sensor
G11 or G21, smoke sensor I / II faults, part 1			
Code	Meaning	Check	Possible causes and rectification
001	Communication ASD <-> smoke sensor	Flat cable connection AMB, smoke sensor	<ul style="list-style-type: none"> • Flat cable not correctly attached or defective → check, replace • Smoke sensor defective → replace • AMB defective → replace
002	Unknown smoke sensor type (manufacturing fault)	Smoke sensor	<ul style="list-style-type: none"> • Replace smoke sensor
004	Response sensitivity too low	Correct smoke sensor installed SSD 535-1, -2, -3	<ul style="list-style-type: none"> • Selected response sensitivity is too low for the deployed smoke sensor type • Use different smoke sensor • Increase response sensitivity
008	Invalid parameter, smoke sensor (manufacturing fault)	Smoke sensor	<ul style="list-style-type: none"> • Replace smoke sensor
G12 or G22, smoke sensor I / II faults, part 2			
Code	Meaning	Check	Possible causes and rectification
001	Smoke sensor chamber	Smoke sensor	<ul style="list-style-type: none"> • Smoke sensor defective → replace
002	Temperature, smoke sensor	ASD ambient temperature Smoke sensor	<ul style="list-style-type: none"> • Adhere to ambient temperature specifications • Smoke sensor defective → replace
004	Supply voltage, smoke sensor	Check ASD operating voltage AMB, smoke sensor	<ul style="list-style-type: none"> • Set operating voltage correctly • AMB defective → replace • Smoke sensor defective → replace
008	EEPROM access fault, smoke sensor	Smoke sensor	<ul style="list-style-type: none"> • Smoke sensor defective → replace
016	EEPROM invalid data, smoke sensor	Smoke sensor	<ul style="list-style-type: none"> • Smoke sensor defective → replace
032	Manufacture, smoke sensor	Smoke sensor	<ul style="list-style-type: none"> • Smoke sensor defective → replace



Continuation:

G30 or G40, airflow monitoring sampling pipe I / II			
Code	Meaning	Check	Possible causes and rectification
001	Pipe blockage, sampling pipe	Sampling pipe, air outlet on the ASD, LS sensor	<ul style="list-style-type: none"> • Check sampling pipe for pipe blockage (sampling holes, air outlet) • Check filter box / filter unit and clean • Check and clean LS sensor
002	Pipe breakage, sampling pipe	Sampling pipe, LS sensor	<ul style="list-style-type: none"> • Check sampling pipe for pipe breakage • Check maintenance hole • Sampling pipe not correctly attached • Junctions open (fittings, flexible transitions) • Check and clean LS sensor
004	Invalid LS-Ü parameter, sampling pipe	Sampling pipe	<ul style="list-style-type: none"> • Outside of range (working point) • Check and clean LS sensor • LS sensor defective → replace
008	Airflow sensor, defective / lacking	Airflow sensor Connection line	<ul style="list-style-type: none"> • Not fitted, not mounted • Connection line defective • LS sensor defective → replace
G50, fan faults			
Code	Meaning	Check	Possible causes and rectification
001	Tacho signal lacking	Check terminals of the fan (white wire)	<ul style="list-style-type: none"> • Poor connection • Fan defective • AMB defective → replace
002	Motor regulation outside of range	Check ASD operating voltage, Check fan connection	<ul style="list-style-type: none"> • Set operating voltage correctly • Fan defective → replace • AMB defective → replace
004	Motor current too low	Fan unit, fan connection	<ul style="list-style-type: none"> • Fan mechanically blocked • Fan defective → replace • AMB defective → replace
G60, initial reset faults			
Code	Meaning	Check	Possible causes and rectification
001	Initial reset value I, airflow too low	Sampling pipe I	<ul style="list-style-type: none"> • Result of G30 / 004
002	Initial reset value II, airflow too low	Sampling pipe II	<ul style="list-style-type: none"> • Result of G40 / 004
004	Initial reset Timeout	Motor run-in time	<ul style="list-style-type: none"> • Waiting time before initial reset not observed • Perform new initial reset
008	Invalid parameters for initial reset I	Sampling pipe I specifications	<ul style="list-style-type: none"> • Observe sampling pipe I specifications • Initial reset was interrupted (by "ASD Off") → new initial reset
016	Invalid parameters for initial reset II	Sampling pipe II specifications	<ul style="list-style-type: none"> • Observe sampling pipe II specifications • Initial reset was interrupted (by "ASD Off") → new initial reset
032	Motor speed during initial reset outside range	Sampling pipe I and/or II specifications	<ul style="list-style-type: none"> • Result of G60 / 008 and/or G60 / 016
064	Initial reset value I, airflow too high	Sampling pipe I	<ul style="list-style-type: none"> • Result of G30 / 004
128	Initial reset value II, airflow too high	Sampling pipe II	<ul style="list-style-type: none"> • Result of G40 / 004

→

Continuation:

G70, RIM 1 / RIM 2 faults			
Code	Meaning	Check	Possible causes and rectification
001	RIM 1 fault	Flat cable connection Module	<ul style="list-style-type: none"> Flat cable not correctly attached or defective → check, replace Module was removed without logging off Module defective → replace
016	RIM 2 fault		
G71, SLM / XLM faults			
Code	Meaning	Check	Possible causes and rectification
001	SLM fault	Flat cable connection Module	<ul style="list-style-type: none"> Flat cable not correctly attached or defective → check, replace Module was removed without logging off Module defective → replace
004	SLM fault, to many SLMs	Number of SLMs	<ul style="list-style-type: none"> only 1 SLM permitted!
016	XLM fault	Flat cable connection Module	<ul style="list-style-type: none"> Flat cable not correctly attached or defective → check, replace Module was removed without logging off Module defective → replace
064	XLM fault, to many XLMs	Number of XLMs	<ul style="list-style-type: none"> only 1 XLM permitted!
G72, BCB / ACB faults			
Code	Meaning	Check	Possible causes and rectification
001	BCB fault	Flat cable connection BCB, ACB	<ul style="list-style-type: none"> Flat cable not correctly attached or defective → check, replace BCB, ACB defective → replace
016	ACB fault		
G73, MCM / SIM faults			
Code	Meaning	Check	Possible causes and rectification
001	MCM fault, lacking or defective	SD memory card Module Flat cable connection	<ul style="list-style-type: none"> SD memory card lacking or not snapped in Flat cable not correctly attached or defective → check, replace SD memory card or module was removed without logging off Module defective → replace
002	MCM fault, communication fault	Flat cable connection Module SD memory card	<ul style="list-style-type: none"> Flat cable not correctly attached or defective → check, replace Module defective → replace SD memory card defective → replace
004	MCM fault, too many MCMs	Number of MCMs	<ul style="list-style-type: none"> Only 1 MCM permitted!
016	SIM fault	Flat cable connection Module	<ul style="list-style-type: none"> Flat cable not correctly attached or defective → check, replace Module was removed without logging off Module defective → replace
064	SIM fault, to many SIMs	Number of SIMs	<ul style="list-style-type: none"> only 1 SIM permitted!
G80, AMB faults			
Code	Meaning	Check	Possible causes and rectification
001	Operating system fault 1	AMB	<ul style="list-style-type: none"> AMB defective → replace
002	Operating system fault 2	AMB	<ul style="list-style-type: none"> AMB defective → replace
004	Undervoltage fault	Operating voltage < 10.4 VDC Conductor cross-section	<ul style="list-style-type: none"> Conductor cross-section too weak → must be enlarged Voltage of the power supply not Ok → check and correct if needed
008	Clock fault	Lithium battery Clock setting	<ul style="list-style-type: none"> Isolation strip still present on the lithium battery → remove Clock is not set Lithium battery defective → replace
016	EEPROM fault	AMB	<ul style="list-style-type: none"> Execute HW reset AMB defective → replace
032	Invalid parameters, Autolearning	Autolearning configuration AMB	<ul style="list-style-type: none"> Re-configure Autolearning (ASD Config) AMB defective → replace
064	Invalid parameters, day/night control	Day/night control configuration AMB	<ul style="list-style-type: none"> Re-configure day/night control (ASD Config) AMB defective → replace

11 Options

11.1 Sampling pipe

When using sampling pipe in extremely corrosive environments, sufficiently resistant tube materials have to be used. Please contact the manufacturer of the ASD 535 for material specifications.



Danger

Tube materials other than those listed in Sec. 5.3 may be used only after consulting with the manufacturer of the ASD 535 and with the manufacturer's written consent.

Only tubes which have been tested and approved by the manufacturer (material, supplier, dimensions) of the ASD 535 may be used (see Sec. 5.3).

11.2 Deployment in severe conditions

Applications with an extremely high level of dust and/or dirt, extreme temperature ranges and/or atmospheric humidity outside the specified limit values require the use of accessory parts as recommended by the manufacturer. For example:

- Filter box / filter unit
- Dust trap
- Dust separator
- Water separator
- Manual ball-cock for sporadic cleaning of the sampling pipe with compressed air
- Automatic blow-out device
- Insulation of the sampling pipe
- Use of cooling sections in the sampling pipe
- Use of specially painted smoke sensors SSD 535-1 CP / SSD 535-2 CP / SSD 535-3 CP.



Notice

Use and application under severe conditions may be implemented only after consulting with the manufacturer and with the supervision of the manufacturer.

When using the above listed accessory parts, it is necessary to perform a sampling pipe calculation with "ASD PipeFlow" (see Sec. 4.3.2 for exceptions).

The initial reset during commissioning must be carried out with the accessory parts required for the severe conditions.

If an additional unit is subsequently deployed in an already installed ASD 535, a new initial reset must be carried out.

11.3 Deploying detector boxes

When defining detection areas (e.g. horizontal localisation in high-rack storage buildings), it may be necessary to deploy additional detector boxes (e.g. REK 511) in the sampling pipe (see Sec. 4.4.4.7). Applicable country-specific guidelines must be observed (e.g. DIN VDE 0833-2 in Germany, Cantonal Fire Insurance Union in Switzerland). Further information about the REK 511 detector box is available in a separate data sheet (T 135 422).



Warning

The REK 511 detector box cannot be operated from the ASD 535. The REK 511 detector box is connected by means of an addressing module directly from the FACP.

When deploying detector boxes, it may be necessary to perform a sampling pipe calculation with "ASD PipeFlow" (see Sec. 4.3.2).

11.4 Deployment in Ex zones

Ex zones may be monitored **only** with the approval of the manufacturer; this requires the use of special accessory parts (explosion protection). If this is the case, **only** the sampling pipe may be located in the Ex zone. The ASD 535 detector housing and accessory parts (explosion protection, filter box, filter unit, detector box, water separator) must be installed outside the Ex zone in a secure area. Return circulation of the air in the Ex zone (monitoring room) is absolutely required. Explosion protection must be installed in the sampling pipe and in the air recirculation line.



Danger

Deployment of the ASD 535 – as described above – in Ex zones may be implemented only after consulting with the manufacturer.

Consulting with the country-specific offices responsible for approval and testing is carried out by the manufacturer of the ASD 535.

When deploying explosion protection, it is imperative to perform a sampling pipe calculation with “ASD PipeFlow”.

11.5 Use in deep-freeze warehouses

The ASD 535 can be used in deep-freeze warehouses as stipulated in the instructions in Application guidelines for deep-freeze warehouses, T 131 390. Special attention must be paid to the following:

- the narrowed system limits concerning maximum tube lengths and the number of sampling holes
- the use of sampling points with heating and their programming with the “ASD Config” configuration software
- the reduced temperature range (–30°C to 0°C).

11.6 ASD network

Several ASDs can be networked with each other using the SIM 35 expansion module. An ASD network can have up to 250 participants. The master module in the ASD network is the SMM 535, by means of which a PC is connected. Using the “ASD Config” configuration software, all ASD 535 units present in the network can be visualised and operated from the PC. The SIM 35 provides galvanic separation between the RS485 interface and the AMB 35 (ASD 35). Simultaneous visualisation of all ASDs with “ASD Config” must be enabled by means of a [Dongle](#) (ask the manufacturer).



Notice

The normative alarm transmission of the ASD 535 to the higher level point does not use the ASD network. The “Alarm” / “Fault” relays in the ASD, or the SecuriPro- / SecuriFire- / Integral addressable loop are to be used from the XLM 35 / SLM 35.

Each SIM 35 and ASD 535 is assigned its own address. They are assigned based on the wiring topology in **ascending order** (see also [Fig. 54](#)).

The SIM 35 has two rotary switches (S1 and S2) for setting the network address (see Sec. 8.5.6).

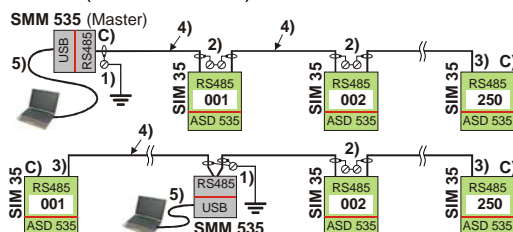

Fig. 54 Design of ASD network

- 1) Screen with equipotential bonding connected, always only on the SMM 535, do not connect on the last SIM 35; **3**).
- 2) Screen connected by means of a lustre terminal.
- 3) If SMM 535 is in the network, do not connect the screen on the first and last SIM 35 (beginning and end).
- 4) Network cable: 4-core, twisted / screened (only 3 wires are used, total length max. 1.000 m).
- 5) USB cable; max. 3 m in length.
- C) There must be bus termination on both sides of the network (beginning and end); jumper “**TERM**”, position “**C**”.

12 Article numbers and replacement parts

12.1 Detector housing and accessories

Designation	Article no.
ASD 535-1 without smoke level indicator, for 1 smoke sensor (without smoke sensor)	5000623.0101
ASD 535-2 without smoke level indicator, for 2 smoke sensors (without smoke sensor)	5000623.0102
ASD 535-3 with smoke level indicator, for 1 smoke sensor (without smoke sensor)	5000623.0103
ASD 535-4 with smoke level indicator, for 2 smoke sensors (without smoke sensor)	5000623.0104
Smoke sensor SSD 535-1; sensitivity: alarm 0.5 %/m – 10 %/m, pre-signals 0.05 %/m – 9 %/m	5000613.0101
Smoke sensor SSD 535-2; sensitivity: alarm 0.1 %/m – 10 %/m, pre-signals 0.01 %/m – 9 %/m	5000613.0102
Smoke sensor SSD 535-3; sensitivity: alarm 0.02 %/m – 10 %/m, pre-signals 0.002 %/m – 9 %/m	5000613.0103
Smoke sensor SSD 535-1 CP (painted); sensitivity: alarm 0.5 %/m – 10 %/m, pre-signals 0.05 %/m – 9 %/m	5000613.2201
Smoke sensor SSD 535-2 CP (painted); sensitivity: alarm 0.1 %/m – 10 %/m, pre-signals 0.01 %/m – 9 %/m	5000613.2202
Smoke sensor SSD 535-3 CP (painted); sensitivity: alarm 0.02 %/m – 10 %/m, pre-signals 0.002 %/m – 9 %/m	5000613.2203
eXtended Line Module XLM 35 including mounting set	11-2200003-01-XX
SecuriLine module SLM 35 including mounting set	4000286.0101
Relay Interface Module RIM 35 including mounting set	4000287.0101
Memory Card Module MCM 35 with SD memory card (industrial version) including mounting set	4000285.0101
SD memory card (industrial version)	11-4000007-01-XX
Serial Interface Module SIM 35, including mounting set	11-2200000-01-XX
Serial Master Module SMM 535	11-2200001-01-XX
USB cable, 4.5 m	4301248
Printed circuit board Main Board AMB 35-1 (for ASD 535-1 / -3)	94301218.0101
Printed circuit board Main Board AMB 35-2 (for ASD 535-2 / -4)	94301218.0102
Printed circuit board without smoke level indicator BCB 35	4301220.0101
Printed circuit board with smoke level indicator ACB 35	4301221.0101
Aspirating fan unit AFU 35, complete	4000299
Airflow sensor AFS 35	4000300
Insect Protection Screen IPS 35 (set of 2)	11-2300012-01-XX
Lithium battery	11-4000002-01-XX
Cable screw union M20 (set of 10)	11-4000003-01-XX
Cable screw union M25 (set of 10)	11-4000004-01-XX
Adapters for US cable screw unions AD US M-Inch	11-2300029-01-XX
Universal Module Support UMS 35	4301252.0101

12.2 Sampling pipe and accessories

The article numbers of all available parts of the sampling pipe (tubes, fittings, etc.) are listed in a separate document (T 131 194).

13 Technical data

Type				ASD 535	
Supply voltage range	10.5 to 30 (UL/FM = 12.4 to 27)			VDC	
Max. power consumption, measured in Fan speed level V and at →	12 VDC operation	24 VDC operation	Typical		
	10.5 VDC ①	18 VDC ①	24 VDC		
ASD 535-1	Idle/fault	approx. 575	approx. 340	approx. 260	mA
	Alarm I	approx. 660	approx. 390	approx. 295	mA
ASD 535-2	Idle/fault	approx. 645	approx. 380	approx. 290	mA
	Alarm I + II	approx. 745	approx. 450	approx. 350	mA
ASD 535-3	Idle/fault	approx. 575	approx. 340	approx. 260	mA
	Alarm I	approx. 695	approx. 405	approx. 310	mA
ASD 535-4	Idle/fault	approx. 645	approx. 380	approx. 290	mA
	Alarm I + II	approx. 820	approx. 490	approx. 385	mA
	additionally with 1 RIM 35 units	approx. 15	approx. 10	approx. 7	mA
	additionally with 2 RIM 35 units	approx. 30	approx. 20	approx. 14	mA
	additionally with XLM 35 / SLM 35	approx. 20	approx. 10	approx. 5	mA
	additionally with MCM 35	approx. 25	approx. 15	approx. 10	mA
	additionally with SIM 35	approx. 20	approx. 10	approx. 5	mA
	SMM 535 (not from ASD but rather from PC via USB connection)			max. 100	mA
Switch-on current peak ② (caused by EMC protection elements on the ASD supply input)				approx. 5 for max. 1	A ms
Sampling pipe length				see Sec. 4.2.1	
Sampling pipe Ø, typical (inner/outer)				Ø 20 / 25	mm
Max. number of sampling holes				see Sec. 4.2.1	
Sampling hole diameter				Ø 2 / 2.5 / 3 / 3.5 / 4 / 4.5 / 5 / 5.5 / 6 / 6.5 / 7	mm
Response range (smoke sensor sensitivity see Sec. 12.1)				EN 54-20, class A, B, C	
Protection type acc. to IEC 529 / EN 60529 (1991)				54	IP
Ambient conditions acc. to IEC 721-3-3 / EN 60721-3-3 (1995)				3K5 / 3Z1	class
<ul style="list-style-type: none"> Extended ambient conditions: Detector housing temperature range Temperature range of detector housing to Australian Standard AS 1603.8 Sampling pipe temperature range Temperature range of sampling pipe to Australian Standard AS 1603.8 Max. approved temperature fluctuation in detector housing and sampling pipe operation Max. permitted storage temperature of detector housing (without condensation) Ambient pressure difference of detector housing to sampling pipe (sampling holes) Detector housing humidity ambient condition (transient without condensation) Detector housing and sampling pipe humidity ambient condition (continuous) 				-30 – +60 (UL max. +40) -30 – +55 -30 – +60 ③ -30 – +55 20 ③ -30 – +70 must be identical 95 ③ % rel. hum. 70 ③ % rel. hum.	°C °C °C °C °C °C °C % rel. hum. % rel. hum.
Max. loading capacity relay contact				50 (UL max. 30)	VDC
				1	A
				30	W
Max. loading capacity per open collector output (electrical strength 30 VDC)				100	mA
Plug-in terminals				2.5	mm ²
Cable entry for cable Ø				Ø 5 – 12 (M20) / Ø 9 – 18 (M25)	mm
Noise level (at fan speed level III)				43	dB (A)
Housing material				ABS blend, UL 94-V0	
Housing colour				grey 280 70 05 / anthracite violet 300 20 05	RAL
Approvals				EN 54-20 / FM 3230-3250 / UL 268 / ULC-S529	
Dimensions (W x H x D)				265 x 397 x 148	mm
Weight (ASD 535-4, incl. expansion modules)				max. 3,850	g



Notice

- ① Power consumption at maximum permitted voltage drop in the electrical installation (guideline value for calculating the conductor cross-section).
- ② May cause an immediate actuation of the protection circuit in power supplies with overload protection circuits (primarily in devices with no emergency power supply and output current of < 1.5 A).
- ③ Lower or higher temperature ranges are possible after consulting with the manufacturer. The manufacturer must be consulted if deployment is to be in the condensation range.

14 List of figures

Fig. 1	General operating principle	22
Fig. 2	Block diagram	23
Fig. 3	Workflow of project-specific programming.....	25
Fig. 4	Mechanical design	34
Fig. 5	Electrical design.....	36
Fig. 6	“ASD PipeFlow” program interface.....	40
Fig. 7	Examples of planning with “ASD PipeFlow” calculation.....	43
Fig. 8	Examples of planning without “ASD PipeFlow” calculation.....	43
Fig. 9	Sampling pipe definitions	44
Fig. 10	Size of sampling holes	47
Fig. 11	Examples of sampling pipe layouts in high-rack storage buildings	49
Fig. 12	Equipment monitoring layout variants (examples).....	51
Fig. 13	Two-detector dependency.....	54
Fig. 14	Air recirculation for differing climate zones	54
Fig. 15	Workflow of project-specific programming and adjustment.....	55
Fig. 16	Dimensioned drawing, ASD 535 detector housing drilling plan	60
Fig. 17	Opening, closing and fastening the detector housing.....	63
Fig. 18	Mounting position and pipe entries on the detector housing.....	64
Fig. 19	Removal of the air outlet pipe plug	65
Fig. 20	Turning the labelling strips	65
Fig. 21	Cutting the tubes	68
Fig. 22	Joining the tubes	68
Fig. 23	Vertical sampling pipe	68
Fig. 24	90° bend, branching point	68
Fig. 25	Screw-free fastening of a sampling fixture.....	69
Fig. 26	Transition from fitting to flexible tube.....	70
Fig. 27	Making the sampling holes.....	71
Fig. 28	Mounting clips	71
Fig. 29	Using sampling funnels	71
Fig. 30	Mounting the ceiling duct.....	72
Fig. 31	Mounting accessory parts	73
Fig. 32	Deploying the smoke sensors	75
Fig. 33	Installing expansion modules	76
Fig. 34	Types of power supply	79
Fig. 35	Reset input.....	79
Fig. 36	Control via supply with relay.....	80
Fig. 37	Control via the “Reset external” input.....	81
Fig. 38	Wiring for zone detection.....	82
Fig. 39	Wiring for selective identification or addressable loop	83
Fig. 40	Wiring from XLM 35 / SLM 35	83
Fig. 41	Wiring the OC outputs	84
Fig. 42	Opened detector housing for commissioning	85
Fig. 43	Control and indicator elements on the AMB 35	86
Fig. 44	Configuration overview.....	87
Fig. 45	Commissioning workflow using EasyConfig	89
Fig. 46	Commissioning workflow with “ASD Config” configuration software.....	90
Fig. 47	View of the indication and control elements	101
Fig. 48	XLM 35 / SLM 35 indication and control.....	109
Fig. 49	MCM 35 indication and control.....	109
Fig. 50	SIM 35 indication and control	110
Fig. 51	SMM 535 indication and control	111
Fig. 52	Removing the aspirating fan unit	116
Fig. 53	Removing the airflow sensors	117
Fig. 54	Design of ASD network	124